

Wiring Devices

# Catalogue



# Contents

- **Page 1/4**  
**Ultimate**  
Ultimate slimline, Ultimate screwless, Ultimate flat plate, Ultimate low profile
  
- **Page 2/100**  
**Lisse**  
Lisse curved white moulded
  
- **Page 3/120**  
**Exclusive**  
Exclusive square edge white moulded, Exclusive decorative, Exclusive metal clad
  
- **Page 4/154**  
**T2 Ceiling Accessories**  
Ceiling accessories, back boxes
  
- **Page 5/162**  
**E-Series Polycarbonate**  
E-Series polycarbonate
  
- **Page 6/172**  
**Weatherproof**  
IP55, IP66, Kavacha
  
- **Page 7/184**  
**56 Series**  
Industrial switchgear
  
- **Page 8/196**  
**Occupancy & Presence detection**  
ARGUS presence detector system, Stand-alone Occupancy sensors, Clipsal C-Bus

Ultimate slimline



Ultimate screwless,



Ultimate flat plate



Ultimate low profile



Lisse curved white moulded



Exclusive square edge white moulded



Exclusive decorative



Exclusive metal clad



Ceiling accessories



back boxes



E-Series polycarbonate



IP55



IP66



Kavacha



Industrial switchgear



ARGUS presence detector system



Stand-alone Occupancy sensors



Clipsal C-Bus



ULTIMATE



# A family of styles brought together by design

From the understated design of slimline white moulded to chic screwless flat plate, Ultimate wiring accessories provide sophisticated styles to suit all interiors.

Packed with innovative technical features and time saving installation benefits, Ultimate wiring accessories are an essential compliment for every installation.



## **Slimline White Moulded:**

Offering a stylish, modern alternative, Ultimate slimline white moulded meets the highest specification to enhance any installation with a full compliment of Part M and Essential Supply solutions.



## **Screwless Flat Plate:**

Indulge in ultimate luxury with seamless lines and no visible screws. Combining fashion and functionality, the Ultimate Screwless flat plate range provides the perfect solution for customers looking for a cutting edge modern design with the latest installation features and benefits.

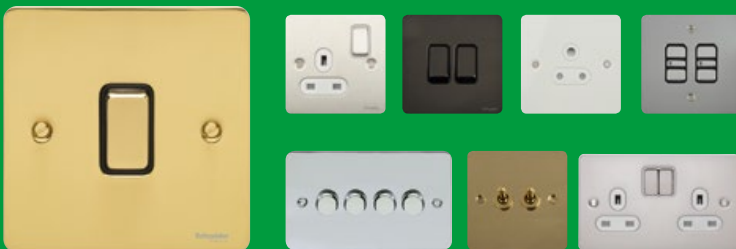

## **Flat Plate:**

Add that special touch to any interior – Ultimate flat plate combines superior engineering with 1.5mm ultra slim, ultra chic flat plate design. The comprehensive array of finishes ensures that you will always find the perfect compliment to your design.

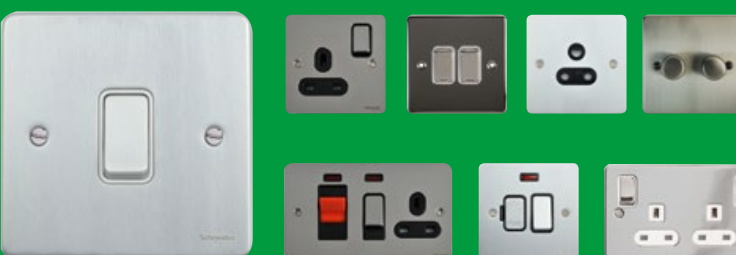

## **Low Profile:**

Ultimate low profile offers a contemporary and refreshing twist on traditional designs with its softly curved edge and quality metal finishes. With its forgiving 5mm plate depth to accommodate uneven wall surfaces., it is also an ideal solution for remodel and renovation projects.

# Unparalleled Design Quality

**Ultra slim construction:** Minimal back projection for an easy fit into standard mounting boxes

**Comprehensive product range:** Wide choice of devices to satisfy installation requirements

**Contemporary aesthetics:** Sleek finish with screw cap covers and tactile switch action with rounded rockers

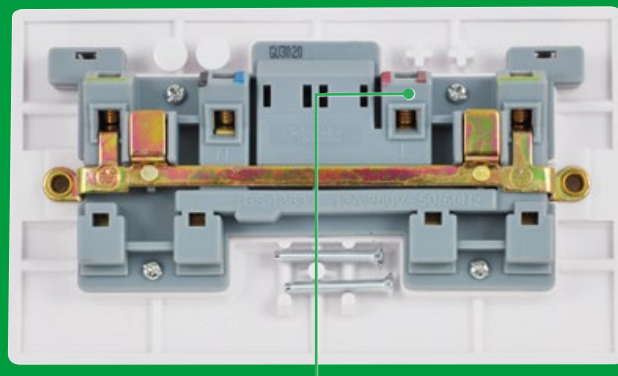

**Ease of installation:** Colour-coded, in-line and angled socket terminals for clear visibility

# Easier Ordering

Whether you are interested in **ULTIMATE Slimline, Screwless Flat Plate, Flat Plate or Low Profile**, simplify your ordering experience with a common part reference framework across the entire Ultimate range - saving you time and avoiding hassle.

- 1 Plate switches
- 2 20AX switches & flex outlets
- 3 Sockets
- 4 50A switches & 45A control units
- 5 Fused connection units
- 6 Dimmers
- 7 Shaver sockets & data communication
- 8 Blank plates

switched  
unswitched  
number of gangs  
number of ways

- SS Stainless Steel
- PC Polished Chrome
- PW Painted White
- PN Pearl Nickel
- BN Black Nickel
- LK Painted Black
- CLR Transparent
- BK Piano Black
- WH Gloss White

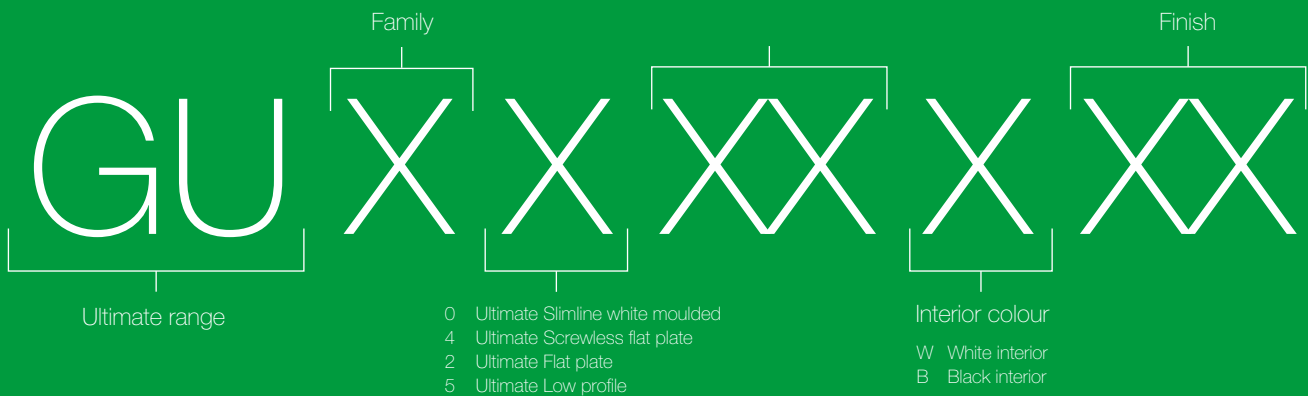

## Grid Solutions

The comprehensive ULTIMATE grid system has been specially designed to bring beauty and style to commercial and residential spaces.

With a vast array of modules to choose from, including data and communications, ULTIMATE grid can provide the ideal solution for highly technical specifications

## Rocker Printing and Engraving

From hob to wine cooler, the ULTIMATE range offer both printing and engraving options for a truly tailored wiring solution. Custom options available.

## Simple as 1, 2, 3...



Fit installation box and mounting grid. Pull through cables, cut and strip to length.



Terminate each cable to the appropriate switch (clear terminal markings).



Once wired, the modules simply but securely clip into the mounting grid.



Finally after decorating, fit the cover plate.



Front plates are available in a choice of 11 finishes - Polished Brass, Mirror Steel, Stainless Steel, Pearl Nickel, Black Nickel, Brushed Chrome, White Metal, White Moulded, Metal Clad Grey and Silver Grey.

# ULTIMATE Slimline White Moulded

True to its name, the Ultimate Slimline range offers one of the most slender, elegantly crafted white moulded accessory ranges on the market today.

And this premium design isn't just skin deep – turn the product over to see tailored features that will make installation faster and easier. A vast compliment of Part M, Essential Supply, and wide rocker options will ensure that you are always prepared for the precise needs of your customers.

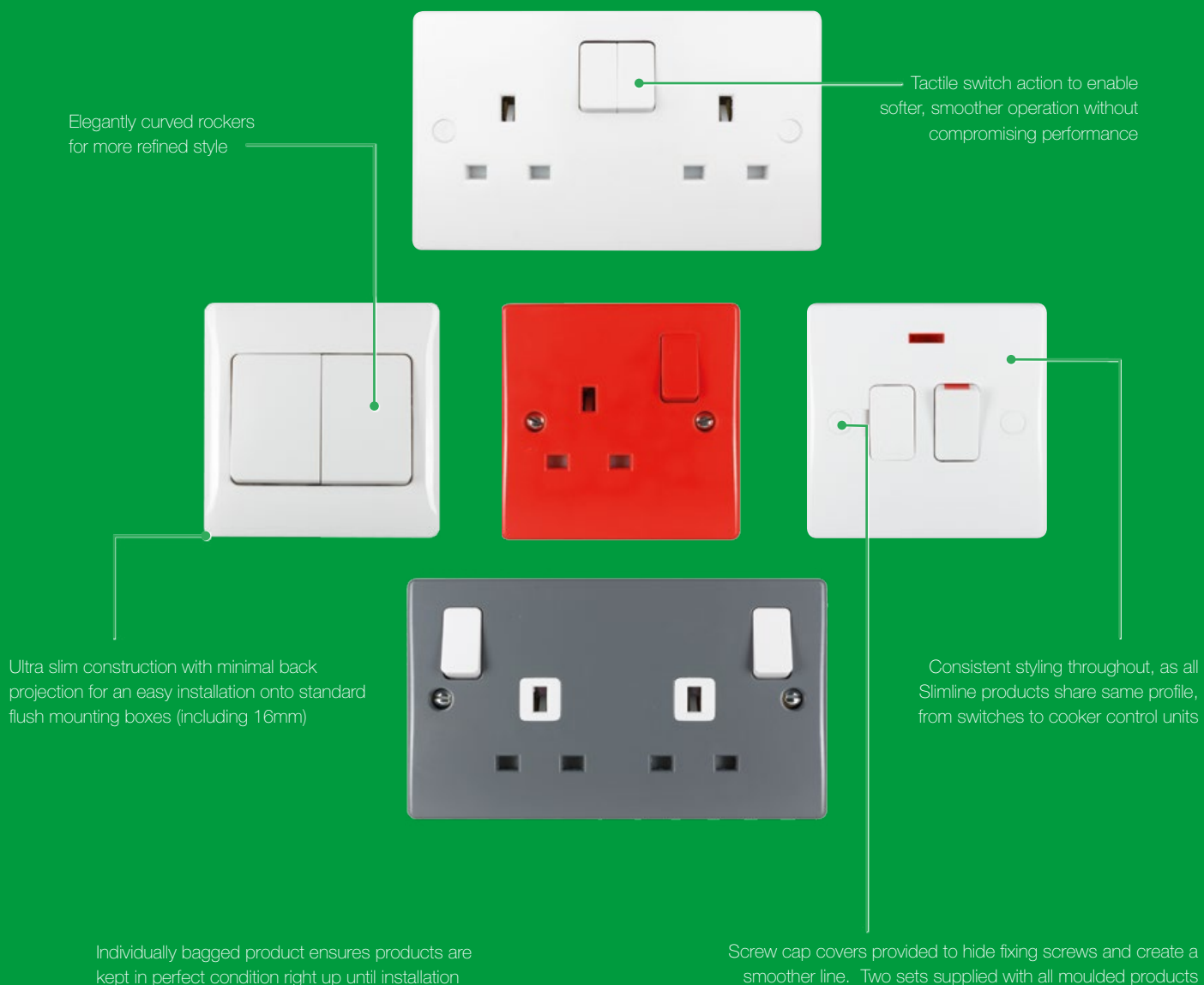



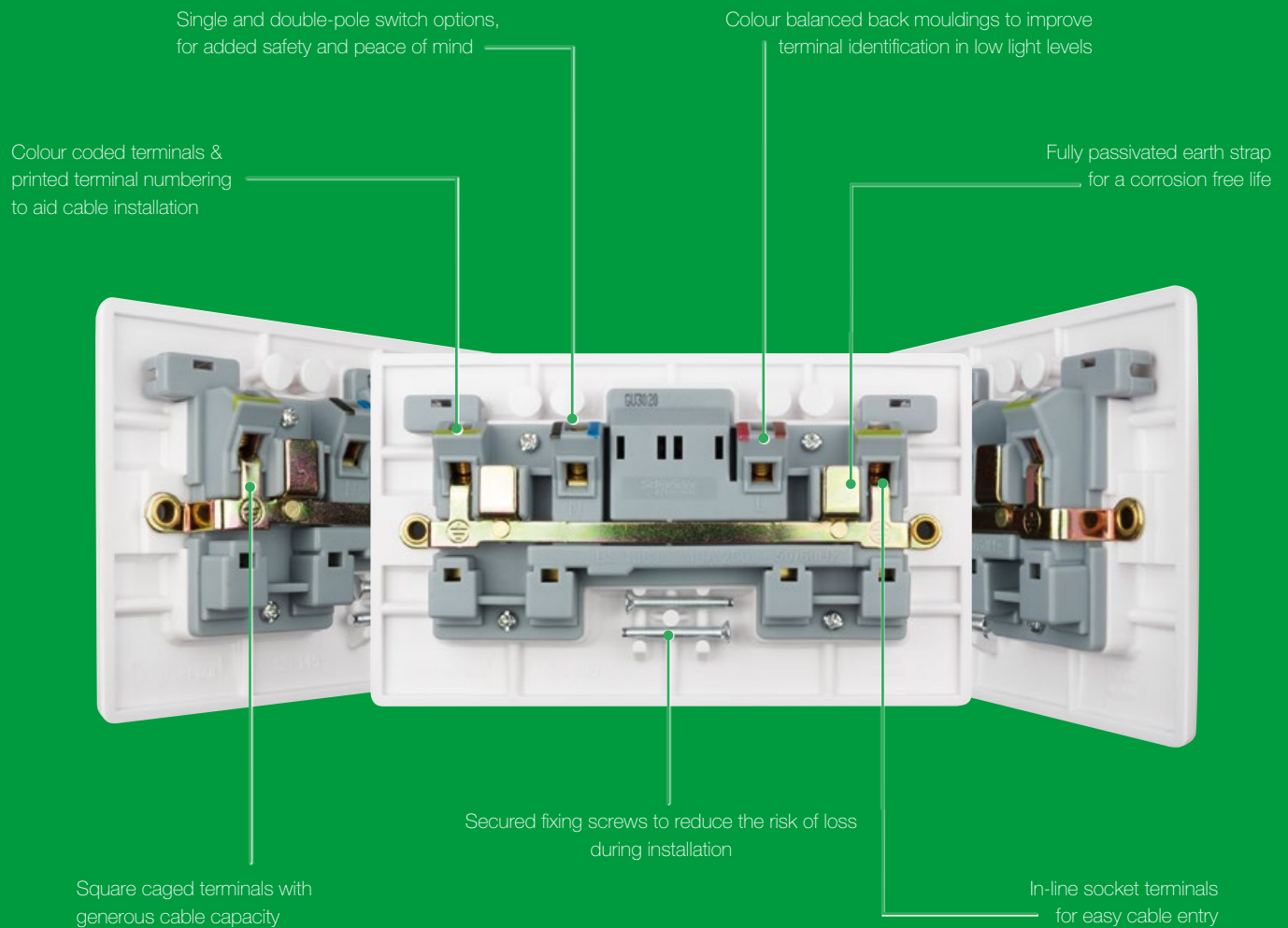

## Specification Highlights



LED dimming solutions tested with leading lamp manufacturers and future-proofed switch ratings of 16AX, to satisfy all lighting demands



50A rated plate switches for switching appliances with higher current ratings, such as heaters, cookers and commercial refrigerating units



Twin earth terminals on 2 gang sockets enable installation in areas requiring high integrity earthing



Unique integral locking facility on isolator for enhanced safety



Comprehensive Part M compliant solution including socket outlets with outboard rockers, wide rocker switches, and grey faceplates



Colour coded in-line terminals as well as a colour balanced back moulding makes terminals easily identifiable during installation, particularly in lower light levels

# Socket outlets

## 1 3A unswitched socket outlets



GU3050



GU3060

Product code	Description	Pack qty
GU3050	1 gang	10
GU3060	2 gang	5
GU3060RD	2 gang - red	5

- **Standard of compliance:**  
BS 1363 (13A)  
BS 546 (round pin)
- **Mounting box:**  
Minimum 25mm deep
- **Fixing screws:**  
M3.5 x 30mm
- **Plate dimensions:**  
86 x 86mm (1 gang)  
86 x 146mm (2 gang)

## 1 3A switched socket outlets



GU3011



GU3020,  
GU3020D

Product code	Description	Pack qty
GU3010	1 gang single-pole	10
GU3011	1 gang single-pole with neon	10
GU3010D	1 gang double-pole	10
GU3010DGY	1 gang double-pole - grey	10
GU3010DRD	1 gang double-pole - red	10
GU3020	2 gang single-pole	5
GU3021	2 gang single-pole with neons	5
GU3020D	2 gang double-pole	5



- **Note:** All 2 gang sockets include twin earth terminals as standard, enabling high integrity earthing. To aid flush installation, 35mm steel boxes are recommended.

## 1 3A switched with outboard rockers socket outlets



GU3033



GU3030GY



GU3030RD

Product code	Description	Pack qty
GU3030	2 gang double-pole	5
GU3030GY	2 gang double-pole - grey	5
GU3030RD	2 gang double-pole - red	5
GU3031	2 gang double-pole with clean earth	5
GU3033	2 gang double-pole, non-standard with clean earth	5

## 1 3A switched with red neon outboard rockers socket outlets



GU3032



GU3034

Product code	Description	Pack qty
GU3032	2 gang double-pole with clean earth	5
GU3034	2 gang double-pole, non-standard with clean earth	5

## Round pin socket outlets



Product code	Description	Pack qty
GU3070	2A unswitched	10
GU3080	5A unswitched	10
GU3090	15A switched	10
GU3091	15A switched with neon	10

- **Standard of compliance:** BS 546
- **Mounting box:** Minimum 25mm deep
- **Fixing screws:** M3.5 x 30mm
- **Plate dimensions:** 86 x 86mm

## Plate switches

### 16AX 1 gang plate switches



Product code	Description	Pack qty
GU1011	1 way	10
GU1012	2 way	10
GU1012GY	2 way - grey	10
GU1014	Intermediate	10
GU1014GY	Intermediate - grey	10

- **Standard of compliance:** BS EN 60669-1
- **Mounting box:** 16mm deep (1-2 gang)  
25mm deep (3-6 gang)
- **Fixing screws:** M3.5 x 18mm
- **Plate dimensions:** 86 x 86mm (1-3 gang standard rocker)  
86 x 146mm (4-6 gang standard rocker)

### 16A 1 gang retractive plate switches



Product code	Description	Pack qty
GU1012R	2 way	10
GU1012RGY	2 way - grey	10
GU1012RP	2 way printed with press	10
GU1012RB	2 way printed with a bell symbol	10

### 16AX multi gang plate switches



Product code	Description	Pack qty
GU1022	2 gang 2 way	10
GU1022GY	2 gang 2 way - grey	10
GU1032	3 gang 2 way	10
GU1032GY	3 gang 2 way - grey	10
GU1042	4 gang 2 way	5
GU1062	6 gang 2 way	5

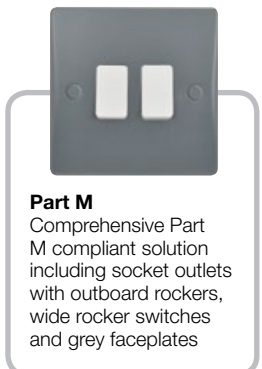

## Plate switches continued

### 10A triple pole isolator



GU1013

Product code	Description	Pack qty
GU1013	10A triple pole isolator	10

### 1 gang wide rocker



GRWH1012, GRWH1014

GRWH1012GY, GRWH1014GY



GRGYWF01

Product code	Description	Pack qty
GRWH1012	16AX 1 gang 2 way	10
GRWH1012GY	16AX 1 gang 2 way - grey	10
GRWH1014	10AX 1 gang intermediate	10
GRWH1014GY	10AX 1 gang intermediate - grey	10
GRGYWF01	Replacement grey frame	10

### 1 6AX multi gang wide rocker



GRWH1032A

GRWH1022GY

Product code	Description	Pack qty
GRWH1022	2 gang 2 way	10
GRWH1022GY	2 gang 2 way - grey	10
GRWH1032A	3 gang 2 way	10
GRWH1032GY	3 gang 2 way - grey	10
GRGYWF01	Replacement grey frame	10

### 10AX architrave



GU1012A

GU1022A

Product code	Description	Pack qty
GU1012A	1 gang 2 way	10
GU1022A	2 gang 2 way	10

### Ceiling pull cords



GPULLGY

GPULLRD

Product code	Description	Pack qty
GPULLGY	1.5m with single bangle - grey	10
GPULLRD	1.5m with twin bangle - red	10

- Standard of compliance:**  
 BS EN 60669-1  
 BS EN 60947-3  
 (GU1013)
- Mounting box:**  
 16mm deep  
 (GU1013 and architrave)  
 25mm deep (wide rocker)
- Fixing screws:**  
 M3.5 x 18mm (GU1013 and architrave), M3.5 x 25mm (wide rocker)
- Plate dimensions:**  
 86 x 86mm  
 (GU1013)
- 87 x 87mm (wide rocker)
- 33 x 86mm (1 gang architrave)
- 33 x 148mm (2 gang architrave)
- Technical notes:**  
 Ceiling switches are sold separately to GPULLGY & GPULLRD.

# Dimmer switches

## Mains & low voltage

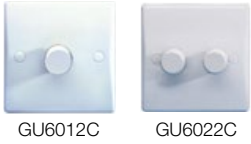

GU6012C

GU6022C

Product code	Description	Pack qty
GU6012C	1 gang 2 way 400W/VA	1
GU6022C	2 gang 2 way 250W/VA	1
GU6032C	3 gang 2 way 250W/VA	1
GU6042C	4 gang 2 way 250W/VA	1

- **Standard of compliance:**  
BS EN 60669-2-1
- **Mounting box:**  
25mm deep
- **Fixing screws:**  
M3.5 x 30mm
- **Plate dimensions:**  
86 x 86mm (1 gang)  
86 x 146mm (2 gang)
- Leading edge control

## LED



GU6032L



GU6042L

Product code	Description	Pack qty
GU6012L	1 gang 2 way 100W/VA	1
GU6022L	2 gang 2 way 100W/VA	1
GU6032L	3 gang 2 way 75W/VA	1
GU6042L	4 gang 2 way 75W/VA	1

- **Standard of compliance:**  
BS EN 60669-2-1
- **Mounting box:**  
25mm deep
- **Fixing screws:**  
M3.5 x 30mm
- **Plate dimensions:**  
86 x 86mm (1 gang)  
86 x 146mm (2 gang)
- Trailing edge control
- **Note:** 1 and 2 gang dimmer switches include spacing frame for mounting in plaster depth 16mm boxes"

# Control switches & flex outlet plates

## 20AX DP 1 gang switched



GU2010

GU2010GY



GU2011HT

Product code	Description	Pack qty
GU2010	20AX DP 1 gang switched	10
GU2010GY	20AX DP 1 gang switched - grey	10
GU2010HT	20AX DP 1 gang switched engraved heater	10
GU2010OV	20AX DP 1 gang switched engraved oven	10
GU2011	20AX DP 1 gang switched with neon	10
GU2011HT	20AX DP 1 gang switched with neon engraved heater	10
GU2011OV	20AX DP 1 gang switched with neon engraved oven	10
GU2011TR	20AX DP 1 gang switched with neon engraved towel	10

- **Standard of compliance:**  
BS EN 60669-1
- **Mounting box:**  
25mm deep
- **Fixing screws:**  
M3.5 x 30mm
- **Plate dimensions:**  
86 x 86mm

## 20AX DP 1 gang switched with flex outlet



GU2013TR

GU2014



GU2014WH

Product code	Description	Pack qty
GU2013	20AX DP 1 gang switched with flex outlet	10
GU2013HT	20AX DP 1 gang switched with flex outlet engraved heater	10
GU2013TR	20AX DP 1 gang switched with flex outlet engraved towel rail	10
GU2014	20AX DP 1 gang switched with flex outlet and neon	10
GU2014HT	20AX DP 1 gang switched with flex outlet and neon engraved heater	10
GU2014WH	20AX DP 1 gang switched with flex outlet and neon engraved water heater	10

## Control switches & flex outlet plates continued

### 32A DP 1 gang switched



GU4031

Product code	Description	Pack qty
GU4031	32A DP 1 gang switched with neon	10

- **Standard of compliance:** BS EN 60669-1 (GU4031) BS 5733 (flex outlet plates)

- **Mounting box:** 25mm deep

- **Fixing screws:** M3.5 x 30mm

- **Plate dimensions:** 86 x 86mm

### Flex outlet plates



GU2033



GU2003

Product code	Description	Pack qty
GU2033	25A side entry	10
GU2003	20A front entry	10

## Fused connection units

### 13A unswitched



GU5000



GU5000MW



GU5000RD



GU5003TR

Product code	Description	Pack qty
GU5000	13A unswitched	10
GU5000RD	13A unswitched - red	10
GU5000HT	13A unswitched engraved heater	10
GU5000MW	13A unswitched engraved microwave	10
GU5000SS	13A unswitched engraved security	10
GU5000TR	13A unswitched engraved towel rail	10
GU5000TD	13A unswitched engraved tumble dryer	10
GU5000WD	13A unswitched engraved waste disposal	10
GU5001	13A unswitched with neon	10
GU5003	13A unswitched with flex outlet	10
GU5003TR	13A unswitched with flex outlet engraved towel rail	10
GU5004	13A unswitched with neon & flex outlet	10

- **Standard of compliance:** BS 1363

- **Mounting box:** 25mm deep

- **Fixing screws:** M3.5 x 30mm

- **Plate dimensions:** 86 x 86mm

### 3A unswitched



GU50003



GU50033

Product code	Description	Pack qty
GU50003	3A unswitched	10
GU50033	3A unswitched with flex outlet	10

- **Standard of compliance:** BS 1363

- **Mounting box:** 25mm deep

- **Fixing screws:** M3.5 x 30mm

- **Plate dimensions:** 86 x 86mm

# Fused connection units continued

## 1 3A DP switched



GU5010

GU5010GY



GU5010CH

Product code	Description	Pack qty
GU5010	13A DP switched	10
GU5010GY	13A DP switched - grey	10
GU5010RD	13A DP switched - red	10
GU5010BO	13A DP switched engraved boiler	10
GU5010CH	13A DP switched engraved cooker hood	10
GU5010DW	13A DP switched engraved dish washer	10
GU5010EF	13A DP switched engraved extractor fan	10
GU5010FA	13A DP switched engraved fan	10
GU5010FZ	13A DP switched engraved freezer	10
GU5010FR	13A DP switched engraved fridge	10
GU5010FFZ	13A DP switched engraved fridge/freezer	10
GU5010HO	13A DP switched engraved hob	10
GU5010HT	13A DP switched engraved heater	10
GU5010MW	13A DP switched engraved microwave	10
GU5010TD	13A DP switched engraved tumble dryer	10
GU5010WD	13A DP switched engraved waste disposal	10
GU5010WM	13A DP switched engraved washing machine	10

- **Standard of compliance:** BS 1363
- **Mounting box:** 25mm deep
- **Fixing screws:** M3.5 x 30mm
- **Plate dimensions:** 86 x 86mm

## 1 3A DP switched with neon



GU5011

GU5011GY



GU5011FFZ

Product code	Description	Pack qty
GU5011	13A DP switched with neon	10
GU5011GY	13A DP switched with neon - grey	10
GU5011BO	13A DP switched with neon engraved boiler	10
GU5011CH	13A DP switched with neon engraved cooker hood	10
GU5011DW	13A DP switched with neon engraved dish washer	10
GU5011EF	13A DP switched with neon engraved extractor fan	10
GU5011FA	13A DP switched with neon engraved fan	10
GU5011FZ	13A DP switched with neon engraved freezer	10
GU5011FR	13A DP switched with neon engraved fridge	10
GU5011FFZ	13A DP switched with neon engraved fridge/freezer	10
GU5011HO	13A DP switched with neon engraved hob	10
GU5011HT	13A DP switched with neon engraved heater	10
GU5011MW	13A DP switched with neon engraved microwave	10
GU5011TD	13A DP switched with neon engraved tumble dryer	10
GU5011WD	13A DP switched with neon engraved waste disposal	10
GU5011WM	13A DP switched with neon engraved washing machine	10

- **Standard of compliance:** BS 1363
- **Mounting box:** 25mm deep
- **Fixing screws:** M3.5 x 30mm
- **Plate dimensions:** 86 x 86mm

## 1 3A DP switched with flex outlet



GU5013

GU5014

Product code	Description	Pack qty
GU5013	13A DP switched with flex outlet	10
GU5014	13A DP switched with flex outlet and neon	10

- **Standard of compliance:** BS 1363
- **Mounting box:** 25mm deep
- **Fixing screws:** M3.5 x 30mm
- **Plate dimensions:** 86 x 86mm

# High current switches

## 50A DP switches



GU4011



GU4020

Product code	Description	Pack qty
GU4010	50A 1 gang DP switch	10
GU4011	50A 1 gang DP switch with neon	10
GU4020	50A 2 gang DP switch	5
GU4020GY	50A 2 gang DP switch - grey	5
GU4021	50A 2 gang DP switch with neon	5

- **Standard of compliance:**  
BS EN 60669-1  
(50A DP switches)  
BS 4177 (cooker control units)
- **Mounting box:**  
47mm deep
- **Fixing screws:**  
M3.5 x 30mm
- **Plate dimensions:**  
86 x 86mm (1 gang)  
146 x 86mm (2 gang)

## 45A cooker control unit with 1 3A switched socket



GU4001

Product code	Description	Pack qty
GU4000	45A cooker control unit with 13A switched socket	5
GU4000GY	45A cooker control unit with 13A switched socket grey	5
GU4001	45A cooker control unit with 13A switched socket with neons	5

## Cooker connection unit



GU4050

Product code	Description	Pack qty
GU4050	Cooker connection unit	10

# Shaver socket

## 115/230V dual voltage



GU7090

Product code	Description	Pack qty
GU7090	115/230V dual voltage	1
GU7090GY	115/230V dual voltage grey	1

- **Standard of compliance:**  
BS EN 61558-2-5
- **Mounting box:**  
47mm deep
- **Fixing screws:**  
M3.5 x 30mm
- **Plate dimensions:**  
146 x 86mm (2 gang)

# Telephone outlets

## Single outlet



GU7051

GU7061,  
GU7062

Product code	Description	Pack qty
GU7051	RJ11	10
GU7061	BT master	10
GU7062	BT secondary	10

- **Standard of compliance:**  
BS EN 41003
- **Mounting box:**  
25mm deep
- **Fixing screws:**  
M3.5 x 30mm
- **Plate dimensions:**  
86 x 86mm



# Data outlets

## RJ45 CAT5e outlets



GU7071

GU7072



GU7074

Product code	Description	Pack qty
GU7071	Single	10
GU7072	Twin	10
GU7074	Quad	5

- **Standard of compliance:** BS EN 41003
- **Mounting box:** 25mm deep (single and twin)  
35mm deep (quad)
- **Fixing screws:** M3.5 x 30mm
- **Plate dimensions:** 86 x 86mm (single and twin)  
86 x 146mm (quad)

# TV outlets

## Coaxial sockets



GU7010

GU7020



GU7030

Product code	Description	Pack qty
GU7010	Single TV/FM	10
GU7020	Twin TV/FM	10
GU7030	Single satellite	10
GU7040	Twin satellite	5

- **Standard of compliance:** BS 3041 (where applicable)
- **Mounting box:** 25mm deep
- **Fixing screws:** M3.5 x 30mm
- **Plate dimensions:** 86 x 86mm

## Screened coaxial sockets



GU7021

GU7081

Product code	Description	Pack qty
GU7021	Diplex TV/F	10
GU7081	Triplex TV/FM/SAT	10

# Blank plates & accessories

## Blank plates & accessories



GU8010

GU8020

Product code	Description	Pack qty
GU8010	1 gang blank plate	10
GU8020	2 gang blank plate	10
GUMSCO	White moulded screw cap covers	100
USCREW50SS	M3.5 x 50mm screws	100
3746130	M3.5 x 25mm raised head machine screws	100

- **Standard of compliance:** BS EN 5733
- **Fixing screws:** M3.5 x 30mm
- **Plate dimensions:** 86 x 86mm (1 gang)  
86 x 146mm (2 gang)

# Grid plates

88 x 88mm



Product code	Description	Pack qty
GUG01G	1 gang 88 x 88mm	1
GUG01GGY	1 gang 88 x 88mm - grey	1
GUG02G	2 gang 88 x 88mm	1
GUG02GGY	2 gang 88 x 88mm - grey	1
GBG01	76 x 76 x 42mm flush mounted back box	1

88 x 148mm



Product code	Description	Pack qty
GUG03G	3 gang 88 x 148mm	1
GUG03GGY	3 gang 88 x 148mm - grey	1
GUG04G	4 gang 88 x 148mm	1
GUG04GGY	4 gang 88 x 148mm - grey	1
GBG02	136 x 76 x 42mm flush mounted back box	1

156 x 156mm

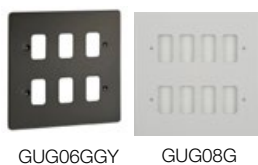

Product code	Description	Pack qty
GUG06G	6 gang 156 x 156mm	1
GUG06GGY	6 gang 156 x 156mm - grey	1
GUG08G	8 gang 156 x 156mm	1
GUG08GGY	8 gang 156 x 156mm - grey	1
GBG03	136 x 136 x 42mm flush mounted back box	1

216 x 156mm

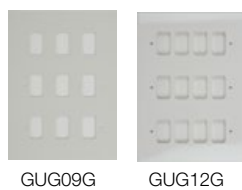

Product code	Description	Pack qty
GUG09G	9 gang 216 x 156mm	1
GUG12G	12 gang 216 x 156mm	1
GBG04F	193 x 133 x 42mm flush mounted back box	1

398 x 156mm

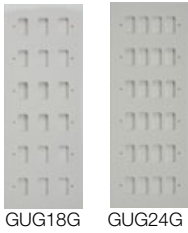

GUG18G GUG24G

Product code	Description	Pack qty
GUG18G	18 gang 398 x 156mm	1
GUG24G	24 gang 398 x 156mm	1
GBG06F	374 x 133 x 42mm flush mounted back box	1

## White moulded grid modules

Switch modules



Switch modules



GUG102W

Product code	Description	Pack qty
GUG101W	10AX 1 way switch module	1
GUG102W	10AX 2 way switch module	1
GUG10IW	10AX intermediate switch module	1
GUG201W	20AX 1 way switch module	1
GUG202W	20AX 2 way switch module	1
GUG20DPW	20AX DP switch module	1

- **Standard of compliance:**  
BS EN 60669-1

20AX DP printed switch modules



GUG20DPMWW



GUG20DPHTW



GUG20DPHOW

Product code	Description	Pack qty
GUG20DPMWW	20AX DP switch module printed microwave	1
GUG20DPCHW	20AX DP switch module printed cooker hood	1
GUG20DPDWW	20AX DP switch module printed dishwasher	1
GUG20DPFZW	20AX DP switch module printed freezer	1
GUG20DPWMW	20AX DP switch module printed washing machine	1
GUG20DPTDW	20AX DP switch module printed tumble dryer	1
GUG20DPHTW	20AX DP switch module printed heater	1
GUG20DPWDYW	20AX DP switch module printed washer dryer	1
GUG20DPOVW	20AX DP switch module printed oven	1
GUG20DPBOW	20AX DP switch module printed boiler	1
GUG20DPWDW	20AX DP switch module printed waste disposal	1
GUG20DPEFW	20AX DP switch module printed extractor fan	1
GUG20DPFAW	20AX DP switch module printed fan	1
GUG20DPFFZW	20AX DP switch module printed fridge freezer	1
GUG20DPFRW	20AX DP switch module printed fridge	1
GUG20DPHOW	20AX DP switch module printed hob	1

## White moulded grid modules continued

### Retractive switch modules



GUG202OCW,  
GUG102RW,  
GUG2020W

Product code	Description	Pack qty
GUG202OCW	6AX 2 way & centre off retractive switch module	1
GUG102RW	10AX 2 way retractive switch module	1
GUG2020W	20AX 2 way on & off retractive switch module	1

- **Standard of compliance:**  
BS EN 60669-1

### Blank & indicator modules



GUGBW



GUGINDWG



GUGINDWO

Product code	Description	Pack qty
GUGBW	Blank module	1
GUGINDWG	Green indicator module	1
GUGINDWR	Red indicator module	1
GUGINDWO	Orange indicator module	1

- **Standard of compliance:**  
BS EN 60669-1  
(blank module)  
BS 5733  
(indicator modules)

## White painted metal grid modules

### Key switch modules



GUG20DPKWPW, GUG202KELWPW  
GUG202KWPW

Product code	Description	Pack qty
GUG20DPKWPW	20AX DP	1
GUG20DPKELWPW	20AX DP printed TEST EMG LTG	1
GUG202KWPW	20AX 2 way	1
GUG202KELWPW	20AX 2 way printed TEST EMG LTG	1

- **Standard of compliance:**  
BS EN 60669-1

### Communication modules



GUGTELMWPW, GUGTELSWPW  
GUGRJ45WPW



GUGCOWPW

Product code	Description	Pack qty
GUGTELMWPW	BT master	1
GUGTELSWPW	BT secondary	1
GUGRJ11WPW	RJ11	1
GUGRJ45WPW	RJ45 CAT5e	1
GUGCOWPW	TV/FM coaxial	1
GUGSATWPW	Satellite	1

- **Standard of compliance:**  
BS EN 41003  
BS EN 3041  
(where applicable)

### Fused connection unit & flex outlet



GUG13FCUWPW GUG16COWPW

Product code	Description	Pack qty
GUG13FCUWPW	13A fused connection unit	1
GUG16COWPW	Flex outlet (10mm diameter)	1

# Euro modular plates & modules

## Euro plates



GU8060



GU8080

Product code	Description	Pack qty
GU8050	1 gang 1 module	10
GU8050GY	1 gang 1 module - grey	1
GU8060	1 gang 2 module	10
GU8060GY	1 gang 2 module - grey	1
GU8080	2 gang 4 module	5
GU8080GY	2 gang 4 module - grey	1

- **Dimensions:**  
86 x 86mm  
(1-2 module),  
86 x 146mm (4 module)
- Refer to module for appropriate mounting box depth

## 25 x 50mm euro modules



GUE7011W



GUE7061W



GUE7071W

Product code	Description	Pack qty
GUE7011W	Single IEC coax (female)	1
GUE7012W	Single IEC coax (male)	1
GUE7030W	Single F type sat	1
GUE7061W	BT master telephone	1
GUE7062W	BT secondary telephone	1
GUE7071W	RJ45 CAT5e (not screened)	1
GUE7072W	RJ45 CAT6 (not screened)	1
GUE7073W	Single USB charger 1A 5Vdc	1
GUE7051W	RJ11 modem	1
GUE7075W	VGA	1
GUE7091W	LexCom Performance outlet	8
GUE7000W	2 x Phono socket	1
GUE7001W	2 x Loudspeaker socket	1
GUE8010W	Blank module	5

- **Dimension:**  
25 x 50mm
- **Mounting Box:**  
25mm deep

## 50 x 50mm euro modules



GUE7010W



GUE7081W



GUE7020W

Product code	Description	Pack qty
GUE7010W	TV/FM diplexer	1
GUE7040W	TV/Sat diplexer	1
GUE7074W	Twin USB charger 2 x 1A 5Vdc	1
GUE7081W	TV/FM/Sat triplexer	1
GUE7082W	TV/FM/Sat1/Sat2 quadplexer	1
GUE7020W	HDMI	1

- **Dimension:**  
50 x 50mm
- **Mounting Box:**  
25mm deep

# Surface pattresses

## 1 gang



GU9116

Product code	Description	Pack qty
GU9116	1 gang 16mm	10
GU9125	1 gang 25mm	10
GU9135	1 gang 35mm	10
GU9147	1 gang 47mm	10

- **Standard of compliance:** BS 5733
- **Technical notes:** All supplied complete with earth terminals.

## 2 gang



GU9D25



GU9235

Product code	Description	Pack qty
GU9225	2 gang 25mm	5
GU9D25	2 gang Dual 25mm	5
GU9235	2 gang 35mm	5
GU9247	2 gang 47mm	5

- **Standard of compliance:** BS 5733
- **Technical notes:** All supplied complete with earth terminals.

## Architrave



GPAT1G16A

Product code	Description	Pack qty
GPAT1G16A	Architrave 1 gang 16mm	10
GPAT2G16A	Architrave 2 gang 16mm	10

- **Standard of compliance:** BS 5733
- **Technical notes:** All supplied complete with earth terminals.

# Flush galvanised steel boxes

## 16mm deep



SB161

Product code	Description	Pack qty
SB161	1 gang	20

- **Standard of compliance:**  
BS 4662

- **Technical notes:**  
Supplied with earth terminal and screw.

## 25mm deep

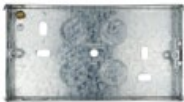

SB252

Product code	Description	Pack qty
SB251	1 gang	10
SB252	2 gang	10

Supplied with fixed and adjustable lugs.

Fitted with selection of 20mm knockouts in sides and back.

## 35mm deep



SB351

Product code	Description	Pack qty
SB351	1 gang	10
SB352	2 gang	5

## 47mm deep



SB472

Product code	Description	Pack qty
SB471	1 gang	10
SB472	2 gang	4

# ULTIMATE Screwless Flat Plate

The ULTIMATE Screwless Flat Plate range provides one of the most comprehensive choices of beautifully crafted, sophisticated fittings on the market. With only a mere 1.5mm front plate depth, this cutting edge screwless design blends seamlessly onto wall surfaces

The wide selection of finish choices within the range will ensure that you always find your perfect match. Choose from Stainless Steel, Polished chrome, Pearl Nickel, Black Nickel, Painted White, Polished Brass, Gloss White, Textured Black, or Transparent

Independent mechanical & electrical connection for enhanced safety

Ultra slim profile: 1.5mm Plate thickness provides a design-led alternative to traditional accessories

Large footprint: Provides extra strength and reduces the need for additional decorating

A choice of 12 finish combinations

Tamperproof front plates with a 4 Point front plate secure connection

Inline angled terminals for easy access during installation

Plated earth straps provide corrosion free life

Two sets of fixing screws to accommodate differing mounting box depths

## Finish Selection

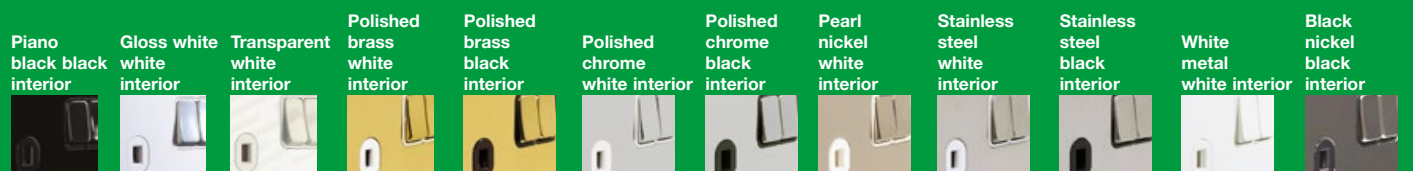





ULTIMATE  
SCREWLESS  
FLAT PLATE



# Solutions for today and tomorrow

The rapid expansion of entertainment and communication devices requires an ever increasing diversity of wiring accessories to power, access and control the technology people use everyday.

Choosing Ultimate accessories not only provides all of the functions needed in the modern home but a choice of styles and finishes to match to the mood and use of every room.



## Dimming solutions.

With any new lamp technology comes the necessity for reliable lighting control and dimming solutions. Schneider Electric's goal is to exceed your expectations with a dimming experience that is as smooth and efficient as possible.



## Let creativity reign with the Ultimate Screwless Transparent range.

Whether matching a favourite wallpaper to create a seamless, unblemished design, or inserting a unique family photo, your customers can pick and choose the perfect image to fit their accessories.

To create their own personal design, Homeowners can download the Schneider Electric Home Touch app which is available for Apple iOS and Android platforms from the App and Google Play stores.

## Specification Highlights



Dedicated Key Card Switch to support your Specification project requirements



Glow in the dark frame for easier accessory identification in the night hours. Wire free – simply clip in place at standard profile thickness



50A rated plate switches for switching appliances with higher current ratings, such as heaters, cookers and commercial refrigerating units



16AX switch rating across all plate switches offers a future-proofed lighting solution to accommodate increased load requirements & fluorescent lighting demands



Tamperproof front plates clip securely in to the mounting frames to added safety and protection. (Requires use of a tool for removal BS 7671)



Colour coded in-line terminals as well as a colour balanced back moulding makes terminals easily identifiable during installation, particularly in lower light levels

# Socket outlets

## 1 3A 1 gang unswitched



GU3450BSS

Product code	Description	Pack qty
GU3450*SS	Stainless steel	1
GU3450*PC	Polished chrome	1
GU3450WPW	Painted white with white interior	1
GU3450WPN	Pearl nickel with white interior	1
GU3450BBN	Black nickel with black interior	1
GU3450*PB	Polished brass	1

- **Standard of compliance:**  
BS 1363 (13A)
- **Mounting box:**  
Minimum 25mm deep
- **Fixing screws:**  
M3.5 x 25mm and 30mm
- **Plate dimensions:**  
88 x 88mm (1 gang)  
88 x 148mm (2 gang)

## 1 3A 2 gang unswitched



GU3460BSS

Product code	Description	Pack qty
GU3460*SS	Stainless steel	1
GU3460*PC	Polished chrome	1
GU3460WPW	Painted white with white interior	1
GU3460WPN	Pearl nickel with white interior	1
GU3460BBN	Black nickel with black interior	1
GU3460*PB	Polished brass	1

## 1 3A 1 gang single-pole switched



GU3410BSS

Product code	Description	Pack qty
GU3410*SS	Stainless steel	1
GU3410*PC	Polished chrome	1
GU3410WPW	Painted white with white interior	1
GU3410WPN	Pearl nickel with white interior	1
GU3410BBN	Black nickel with black interior	1
GU3410*PB	Polished brass	1
GU3410CLR	Transparent with white interior	1

## 1 3A 1 gang double-pole switched

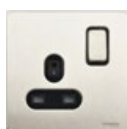

GU3410DBSS

Product code	Description	Pack qty
GU3410D*SS	Stainless steel	1
GU3410D*PC	Polished chrome	1
GU3410DWPW	Painted white with white interior	1
GU3410DWPN	Pearl nickel with white interior	1
GU3410DBBN	Black nickel with black interior	1
GU3410D*PB	Polished brass	1
GU3410DWWH	Gloss white with white interior	1
GU3410DBBK	Piano black with black interior	1



# Socket outlets continued

## 1 3A 1 gang double-pole switched with neon



GU3411DBSS

Product code	Description	Pack qty
GU3411D*SS	Stainless steel	1
GU3411D*PC	Polished chrome	1
GU3411DWPW	Painted white with white interior	1
GU3411DWPN	Pearl nickel with white interior	1
GU3411DBBN	Black nickel with black interior	1
GU3411D*PB	Polished brass	1

- **Standard of compliance:** BS 1363 (13A)
- **Mounting box:** Minimum 25mm deep
- **Fixing screws:** M3.5 x 25mm and 30mm
- **Plate dimensions:** 88 x 148mm (2 gang)

## 1 3A 2 gang single-pole switched



GU3420BSS

Product code	Description	Pack qty
GU3420*SS	Stainless steel	1
GU3420*PC	Polished chrome	1
GU3420WPW	Painted white with white interior	1
GU3420WPN	Pearl nickel with white interior	1
GU3420BBN	Black nickel with black interior	1
GU3420*PB	Polished brass	1
GU3420CLR	Transparent with white interior	1

## 1 3A 2 gang double-pole switched



GU3420DBSS

Product code	Description	Pack qty
GU3420D*SS	Stainless steel	1
GU3420D*PC	Polished chrome	1
GU3420DWPW	Painted white with white interior	1
GU3420DWPN	Pearl nickel with white interior	1
GU3420DBBN	Black nickel with black interior	1
GU3420D*PB	Polished brass	1
GU3420DWWH	Gloss white with white interior	1
GU3420DBBK	Piano black with black interior	1

## 1 3A 2 gang double-pole switched with neons



GU3421DBSS

Product code	Description	Pack qty
GU3421D*SS	Stainless steel	1
GU3421D*PC	Polished chrome	1
GU3421DWPW	Painted white with white interior	1
GU3421DWPN	Pearl nickel with white interior	1
GU3421DBBN	Black nickel with black interior	1
GU3421D*PB	Polished brass	1

## 1 3A 2 gang double-pole switched with clean earth & outboard rockers



GU3431BSS

Product code	Description	Pack qty
GU3431*SS	Stainless steel	1
GU3431*PC	Polished chrome	1
GU3431WPW	Painted white with white interior	1
GU3431WWH	Gloss white with white interior	1

- **Standard of compliance:** BS1363
- **Mounting box:** Minimum 25mm deep
- **Fixing screws:** M3.5 x 25mm and 30mm
- **Plate dimensions:** 88 x 148mm (2 gang)

## 1 3A 2 gang double-pole switched with clean earth & red neon outboard rockers



GU3434BSS

Product code	Description	Pack qty
GU3434*SS	Stainless steel	1
GU3434WPC	Polished chrome with white interior	1

## Socket outlets continued

### 2A unswitched round pin



GU3470BSS

Product code	Description	Pack qty
GU3470*SS	Stainless steel	1
GU3470*PC	Polished chrome	1
GU3470WPW	Painted white with white interior	1
GU3470WPN	Pearl nickel with white interior	1
GU3470BBN	Black nickel with black interior	1
GU3470*PB	Polished brass	1

- **Standard of compliance:** BS 546
- **Mounting box:** Minimum 25mm deep
- **Fixing screws:** M3.5 x 25mm and 30mm
- **Plate dimensions:** 88 x 88mm

### 5A unswitched round pin



GU3480BSS

Product code	Description	Pack qty
GU3480*SS	Stainless steel	1
GU3480*PC	Polished chrome	1
GU3480WPW	Painted white with white interior	1
GU3480WPN	Pearl nickel with white interior	1
GU3480BBN	Black nickel with black interior	1
GU3480*PB	Polished brass	1
GU3480WWH	Gloss white	1

### 1 5A unswitched round pin



GU3490BSS

Product code	Description	Pack qty
GU3490*SS	Stainless steel	1
GU3490*PC	Polished chrome	1
GU3490WPW	Painted white with white interior	1
GU3490WPN	Pearl nickel with white interior	1
GU3490BBN	Black nickel with black interior	1
GU3490*PB	Polished brass	1

## Media plates

### Stacked with 2 x 2 gang double-pole socket outlets & 4 x 2 module euro



GU34204DMPBSS

Product code	Description	Pack qty
GU34204DMP*SS	Stainless steel	1
GU34204DMP*PC	Polished chrome	1
GU34204DMPWPW	Painted white with white interior	1
GU34204DMPWPN	Pearl nickel with white interior	1
GU34204DMPBBN	Black nickel with black interior	1
GU34204DMP*PB	Polished brass	1
GGBSB4724M	Stacked back box	1

- **Standard of compliance:** BS 5733  
BS 1363-2
- **Fixing screws:** M3.5 x 25mm and 30mm
- **Mounting box:** 47mm deep
- **Plate dimensions:** 296 x 86mm (in-line)  
296 x 176mm (stacked)

### In-line with 1 x 2 gang double-pole sockets & 2 x 2 module euro



GU34202DMPBSS

Product code	Description	Pack qty
GU34202DMP*SS	Stainless steel	1
GU34202DMP*PC	Polished chrome	1
GU34202DMPWPW	Painted white with white interior	1
GU34202DMPWPN	Pearl nickel with white interior	1
GU34202DMPBBN	Black nickel with black interior	1
GU34202DMP*PB	Polished brass	1
GGBSB4722M	In-line back box	1

# Plate switches

## 16AX 1 gang 2 way



GU1412BSS

Product code	Description	Pack qty
GU1412*SS	Stainless steel	1
GU1412*PC	Polished chrome	1
GU1412WPW	Painted white with white interior	1
GU1412WPN	Pearl nickel with white interior	1
GU1412BBN	Black nickel with black interior	1
GU1412*PB	Polished brass	1
GU1412BBK	Piano black with black interior	1
GU1412WWH	Gloss white with white interior	1
GU1412CLR	Transparent with white interior	1
GU1400F	1 gang glow in the dark frame	10

- **Standard of compliance:**  
BS EN 60669-1
- **Mounting box:**  
16mm deep  
(1-2 gang)
- **Fixing screws:**  
M3.5 x 25mm and  
30mm
- **Plate dimensions:**  
88 x 88mm (1-3 gang)



## 16AX 1 gang intermediate



GU1414BSS

Product code	Description	Pack qty
GU1414*SS	Stainless steel	1
GU1414*PC	Polished chrome	1
GU1414WPW	Painted white with white interior	1
GU1414WPN	Pearl nickel with white interior	1
GU1414BBN	Black nickel with black interior	1
GU1414*PB	Polished brass	1

- **Technical notes:**  
The glow in the dark frame discreetly signposts the profile of the switch and aids switch location.

## 16A 1 gang 2 way retractive



GU1412RBSS

Product code	Description	Pack qty
GU1412R*SS	Stainless steel	1
GU1412R*PC	Polished chrome	1
GU1412RWPW	Painted white with white interior	1
GU1412RWPN	Pearl nickel with white interior	1
GU1412RBBN	Black nickel with black interior	1
GU1412R*PB	Polished brass	1

## 16AX 2 gang 2 way



GU1422BSS

Product code	Description	Pack qty
GU1422*SS	Stainless steel	1
GU1422*PC	Polished chrome	1
GU1422WPW	Painted white with white interior	1
GU1422WPN	Pearl nickel with white interior	1
GU1422BBN	Black nickel with black interior	1
GU1422*PB	Polished brass	1
GU1422BBK	Piano black with black interior	1
GU1422WWH	Gloss white with white interior	1
GU1422CLR	Transparent with white interior	1



# Plate switches continued

## 16AX 3 gang 2 way

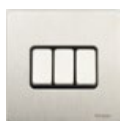

GU1432BSS

Product code	Description	Pack qty
GU1432*SS	Stainless steel	1
GU1432*PC	Polished chrome	1
GU1432WPW	Painted white with white interior	1
GU1432WPN	Pearl nickel with white interior	1
GU1432BBN	Black nickel with black interior	1
GU1432*PB	Polished brass	1
GU1422CLR	Transparent with white interior	1

- **Standard of compliance:**  
BS EN 60669-1  
BS EN 60947-3  
(GU1413\*\*\*)
- **Mounting box:**  
16mm deep (1-2 gang)  
25mm deep (3-6 gang)
- **Fixing screws:**  
M3.5 x 25mm and  
30mm
- **Plate dimensions:**  
88 x 88mm (1-3 gang),  
88 x 148mm (4-6 gang)

## 16AX 4 gang 2 way

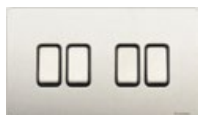

GU1442BSS

Product code	Description	Pack qty
GU1442*SS	Stainless steel	1
GU1442*PC	Polished chrome	1
GU1442WPW	Painted white with white interior	1
GU1442WPN	Pearl nickel with white interior	1
GU1442BBN	Black nickel with black interior	1
GU1442*PB	Polished brass	1

## 16AX 6 gang 2 way



GU1462BSS

Product code	Description	Pack qty
GU1462*SS	Stainless steel	1
GU1462*PC	Polished chrome	1
GU1462WPW	Painted white with white interior	1
GU1462WPN	Pearl nickel with white interior	1
GU1462BBN	Black nickel with black interior	1
GU1462*PB	Polished brass	1

## 10A triple pole isolator



GU1413BSS

Product code	Description	Pack qty
GU1413*SS	Stainless steel	1
GU1413*PC	Polished chrome	1
GU1413WPW	Painted white with white interior	1
GU1413WPN	Pearl nickel with white interior	1
GU1413BBN	Black nickel with black interior	1
GU1413*PB	Polished brass	1
GU1413BBK	Piano black	1

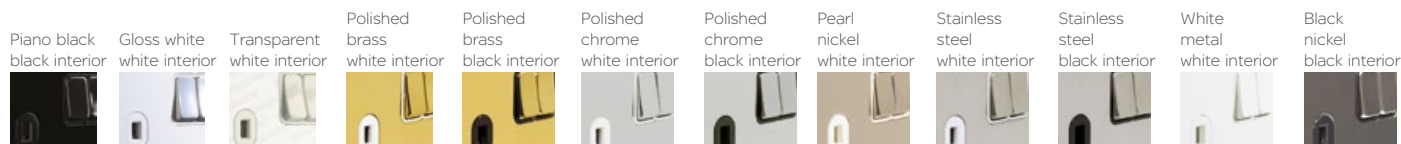



## PIR plate switches

### 1 gang 1 way PIR with override



GUPA1411BSS

Product code	Description	Pack qty
GUPA1411BSS	Stainless steel with black interior	1

### 1 gang 1 way PIR



GUP1411BSS

Product code	Description	Pack qty
GUP1411BSS	Stainless steel with black interior	1

- **Standard of compliance:**  
BS EN 60669-2-1
- **Mounting box:**  
16mm deep
- **Fixing screws:**  
M3.5 x 25mm and 30mm
- **Plate dimensions:**  
88 x 88mm
- **Technical Notes:**  
Operating distance = 6M at 45° horizontal.  
Time setting: 15 sec - 30 mins.  
10 - 2000 Lux.  
2 wire connection.

## Toggle switches

### 16AX 1 gang 2 way



GU1412TSS

Product code	Description	Pack qty
GU1412TSS	Stainless steel	1
GU1412TPC	Polished chrome	1
GU1412TPW	Painted white	1
GU1412TPN	Pearl nickel	1
GU1412TBN	Black nickel	1
GU1412TPB	Polished brass	1
GU1412TCLR	Transparent with white interior	1

- **Standard of compliance:**  
BS EN 60669-1
- **Mounting box:**  
16mm deep  
(1-2 gang)
- **Fixing screws:**  
M3.5 x 25mm and 30mm
- **Plate dimensions:**  
88 x 88mm (1-3 gang)

### 16AX 1 gang intermediate



GU1414TSS

Product code	Description	Pack qty
GU1414TSS	Stainless steel	1
GU1414TPC	Polished chrome	1
GU1414TPW	Painted white	1
GU1414TPN	Pearl nickel	1
GU1414TBN	Black nickel	1
GU1414TPB	Polished brass	1

### 16AX 2 gang 2 way



GU1422TSS

Product code	Description	Pack qty
GU1422TSS	Stainless steel	1
GU1422TPC	Polished chrome	1
GU1422TPW	Painted white	1
GU1422TPN	Pearl nickel	1
GU1422TBN	Black nickel	1
GU1422TPB	Polished brass	1
GU1422TCLR	Transparent with white interior	1

# Toggle switches continued

## 16AX 3 gang 2 way



GU1432TSS

Product code	Description	Pack qty
GU1432TSS	Stainless steel	1
GU1432TPC	Polished chrome	1
GU1432TPW	Painted white	1
GU1432TPN	Pearl nickel	1
GU1432TBN	Black nickel	1
GU1432TPB	Polished brass	1

- **Standard of compliance:**  
BS EN 60669-1
- **Mounting box:**  
35mm deep (3 gang)  
25mm deep (4 gang)
- **Fixing screws:**  
M3.5 x 25mm and  
30mm
- **Plate dimensions:**  
88 x 88mm (3 gang)  
88 x 148mm (4 gang)

## 16AX 4 gang 2 way



GU1442TSS

Product code	Description	Pack qty
GU1442TSS	Stainless steel	1
GU1442TPC	Polished chrome	1
GU1442TPW	Painted white	1
GU1442TPN	Pearl nickel	1
GU1442TBN	Black nickel	1
GU1442TPB	Polished brass	1

# Key card switch

## 32A single-pole key card switch with 30 second time delay

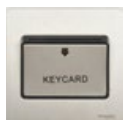

GU1412KBSS

Product code	Description	Pack qty
GU1412K*SS	Stainless steel	1
GU1412K*PC	Polished chrome	1
GU1412KWPW	Painted white with white interior	1
GU1412KWPN	Pearl nickel with white interior	1
GU1412KBBN	Black nickel with black interior	1
GU1412K*PB	Polished brass	1

- **Standard of compliance:**  
BS EN 60669-1
- **Mounting box:**  
47mm deep
- **Fixing screws:**  
M3.5 x 25mm and  
30mm
- **Plate dimensions:**  
88 x 88mm
- **Technical Notes:**  
Non reader type,  
accepts any card (not  
supplied).  
Requires L&N  
connection.  
Will accept cards up to  
85 x 53mm.

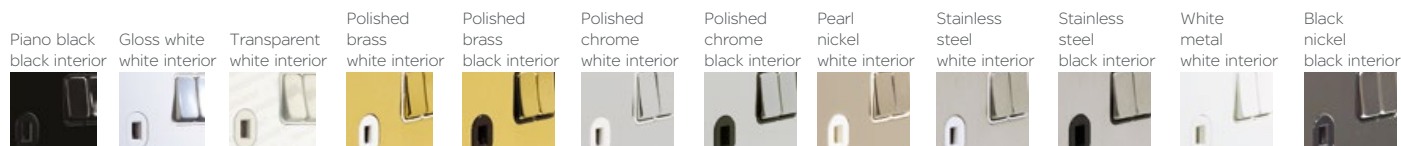

# Dimmer switches

## 1 gang 2 way 400W/VA mains & low voltage



GU6412CSS

Product code	Description	Pack qty
GU6412CSS	Stainless steel	1
GU6412CPC	Polished chrome	1
GU6412CPW	Painted white	1
GU6412CPN	Pearl nickel	1
GU6412CBN	Black nickel	1
GU6412CPB	Polished brass	1

- **Standard of compliance:**  
BS EN 669-2-1
- **Mounting box:**  
25mm deep (1-2 gang)  
35mm deep (3-4 gang)
- **Fixing screws:**  
M3.5 x 25mm and  
30mm
- **Plate dimensions:**  
88 x 88mm (1-2 gang)  
88 x 148mm (3-4 gang)
- **Technical notes:**  
All dimmers not suitable  
with CFL lighting.

## 2 gang 2 way 250W/VA mains & low voltage



GU6422CSS

Product code	Description	Pack qty
GU6422CSS	Stainless steel	1
GU6422CPC	Polished chrome	1
GU6422CPW	Painted white	1
GU6422CPN	Pearl nickel	1
GU6422CBN	Black nickel	1
GU6422CPB	Polished brass	1

Mains & low voltage and  
electronic dimmers not  
suitable for use with LED  
lamps.

Mains & low voltage  
dimmers - leading edge  
control.

LED dimmers - trailing  
edge control.

## 3 gang 2 way 250W/VA mains & low voltage

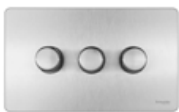

GU6432CSS

Product code	Description	Pack qty
GU6432CSS	Stainless steel	1
GU6432CPC	Polished chrome	1
GU6432CPW	Painted white	1
GU6432CPN	Pearl nickel	1
GU6432CBN	Black nickel	1
GU6432CPB	Polished brass	1

## 4 gang 2 way 250W/VA mains & low voltage



GU6442CSS

Product code	Description	Pack qty
GU6442CSS	Stainless steel	1
GU6442CPC	Polished chrome	1
GU6442CPW	Painted white	1
GU6442CPN	Pearl nickel	1
GU6442CBN	Black nickel	1
GU6442CPB	Polished brass	1

## 1 gang 2 way 100W/VA LED



GU6412LSS

Product code	Description	Pack qty
GU6412LSS	Stainless steel	1
GU6412LPC	Polished chrome	1
GU6412LPW	Painted white	1
GU6412LPN	Pearl nickel	1
GU6412LBN	Black nickel	1
GU6412LPB	Polished brass	1

# Dimmer switches continued

## 2 gang 2 way 100W/VA LED



GU6422LSS

Product code	Description	Pack qty
GU6422LSS	Stainless steel	1
GU6422LPC	Polished chrome	1
GU6422LPW	Painted white	1
GU6422LPN	Pearl nickel	1
GU6422LBN	Black nickel	1
GU6422LPB	Polished brass	1

- **Standard of compliance:**  
BS EN 669-2-1
- **Mounting box:**  
25mm deep (1-2 gang)  
35mm deep (3-4 gang)
- **Fixing screws:**  
M3.5 x 25mm and  
30mm
- **Plate dimensions:**  
88 x 88mm (1-2 gang)  
88 x 148mm (3-4 gang)
- **Technical notes:**  
All dimmers not suitable  
with CFL lighting.

## 3 gang 2 way 75W/VA LED



GU6432LSS

Product code	Description	Pack qty
GU6432LSS	Stainless steel	1
GU6432LPC	Polished chrome	1
GU6432LPW	Painted white	1
GU6432LPN	Pearl nickel	1
GU6432LBN	Black nickel	1
GU6432LPB	Polished brass	1

Mains & low voltage and electronic dimmers not suitable for use with LED lamps.

Mains & low voltage dimmers - leading edge control.

LED dimmers - trailing edge control.

## 4 gang 2 way 75W/VA LED



GU6442LSS

Product code	Description	Pack qty
GU6442LSS	Stainless steel	1
GU6442LPC	Polished chrome	1
GU6442LPW	Painted white	1
GU6442LPN	Pearl nickel	1
GU6442LBN	Black nickel	1
GU6442LPB	Polished brass	1

## 1 gang 2 way 300W/VA electronic



GU6412EBSS

Product code	Description	Pack qty
GU6412E*SS	Stainless steel	1
GU6412E*PC	Polished chrome	1
GU6412EWPW	Painted white with white interior	1
GU6412EWPN	Pearl nickel with white interior	1
GU6412EBBN	Black nickel with black interior	1
GU6412E*PB	Polished brass	1

- **Standard of compliance:**  
60669-2-1
- **Mounting box:**  
Minimum 25mm
- **Fixing screws:**  
M3.5 x 25mm and 30mm
- **Plate dimensions:**  
88 x 88mm (1-2 gang)
- **Technical notes:**  
IR remote unit requires  
remote control.

## 2 gang 2 way 200W/VA electronic



GU6422EBSS

Product code	Description	Pack qty
GU6422E*SS	Stainless steel	1
GU6422E*PC	Polished chrome	1
GU6422EWPW	Painted white with white interior	1
GU6422EWPN	Pearl nickel with white interior	1
GU6422EBBN	Black nickel with black interior	1
GU6422E*PB	Polished brass	1

- All dimmers can be installed on 2 way and multiway circuits.
- For 2 way operating remote, switch must be changed for retractive switch.
- Electronic dimmers not suitable for use with CFL and LED lamps of any type.

## 1 gang 2 way 300W/VA IR electronic



GU6412RBSS

Product code	Description	Pack qty
GU6412R*SS	Stainless steel	1
GU6412R*PC	Polished chrome	1
GU6412RWPW	Painted white with white interior	1
GU6412RWPN	Pearl nickel with white interior	1
GU6412RBBN	Black nickel with black interior	1
GU6412R*PB	Polished brass	1
GU6000RC1	1 channel IR remote control	1

- **Standard of compliance:** 60669-2-1
- **Mounting box:** Minimum 25mm
- **Fixing screws:** M3.5 x 25mm and 30mm
- **Plate dimensions:** 88 x 88mm (1-2 gang)
- **Technical notes:** IR remote unit requires remote control.
- All dimmers can be installed on 2 way and multiway circuits.
- For 2 way operating remote, switch must be changed for retractive switch.
- Electronic dimmers not suitable for use with CFL and LED lamps of any type.

## Control switches

## 20AX double-pole 1 gang



GU2410BSS

Product code	Description	Pack qty
GU2410*SS	Stainless steel	1
GU2410*PC	Polished chrome	1
GU2410WPW	Painted white with white interior	1
GU2410WPN	Pearl nickel with white interior	1
GU2410BBN	Black nickel with black interior	1
GU2410*PB	Polished brass	1
GU2410CLR	Transparent with white interior	1

- **Standard of compliance:** BS EN 60669-1
- **Mounting box:** 35mm deep
- **Fixing screws:** M3.5 x 25mm and 30mm
- **Plate dimensions:** 88 x 88mm

## 20AX double-pole 1 gang with neon



GU2411BSS

Product code	Description	Pack qty
GU2411*SS	Stainless steel	1
GU2411*PC	Polished chrome	1
GU2411WPW	Painted white with white interior	1
GU2411WPN	Pearl nickel with white interior	1
GU2411BBN	Black nickel with black interior	1
GU2411*PB	Polished brass	1
GU2411BBK	Piano black with black interior	1
GU2411WWH	Gloss white with white interior	1

## 20AX double-pole 1 gang with flex outlet



GU2413BSS

Product code	Description	Pack qty
GU2413*SS	Stainless steel	1
GU2413*PC	Polished chrome	1
GU2413WPW	Painted white with white interior	1
GU2413WPN	Pearl nickel with white interior	1
GU2413BBN	Black nickel with black interior	1
GU2413*PB	Polished brass	1

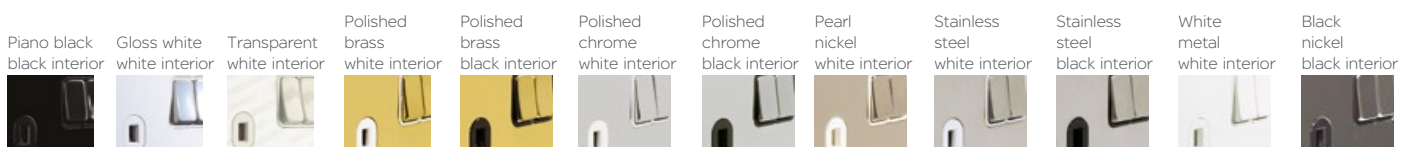

## Control switches continued

### 20AX double-pole 1 gang with neon & flex outlet



GU2412BSS

Product code	Description	Pack qty
GU2414*SS	Stainless steel	1
GU2414*PC	Polished chrome	1
GU2414WPW	Painted white with white interior	1
GU2414WPN	Pearl nickel with white interior	1
GU2414BBN	Black nickel with black interior	1
GU2414*PB	Polished brass	1

- **Standard of compliance:** BS EN 60669-1 (switches)
- **Mounting box:** 35mm deep
- **Fixing screws:** M3.5 x 25mm and 30mm

### 20AX double-pole 1 gang with neon & flex outlet printed water heater



GU2414WHBSS

Product code	Description	Pack qty
GU2414WH*SS	Stainless steel	1
GU2414WH*PC	Polished chrome	1
GU2414WHWPW	Painted white with white interior	1
GU2414WHWPN	Pearl nickel with white interior	1
GU2414WHBBN	Black nickel with black interior	1
GU2414WH*PB	Polished brass	1

### 32A double-pole 1 gang with neon



GU4431BSS

Product code	Description	Pack qty
GU4431*SS	Stainless steel	1
GU4431*PC	Polished chrome	1
GU4431WPW	Painted white with white interior	1
GU4431WPN	Pearl nickel with white interior	1
GU4431BBN	Black nickel with black interior	1
GU4431*PB	Polished brass	1

## Fused connection units

### 1 3A unswitched



GU5400BSS

Product code	Description	Pack qty
GU5400*SS	Stainless steel	1
GU5400*PC	Polished chrome	1
GU5400WPW	Painted white with white interior	1
GU5400WPN	Pearl nickel with white interior	1
GU5400BBN	Black nickel with black interior	1
GU5400*PB	Polished brass	1

- **Standard of compliance:** BS 1363
- **Mounting box:** 25mm deep (unswitched)
- **Fixing screws:** M3.5 x 25mm and 30mm
- **Plate dimensions:** 88 x 88mm

### 1 3A unswitched with flex outlet



GU5403BSS

Product code	Description	Pack qty
GU5403*SS	Stainless steel	1
GU5403*PC	Polished chrome	1
GU5403WPW	Painted white with white interior	1
GU5403WPN	Pearl nickel with white interior	1
GU5403BBN	Black nickel with black interior	1
GU5403*PB	Polished brass	1

# Fused connection units continued

## 1 3A double-pole switched



GU5410BSS

Product code	Description	Pack qty
GU5410*SS	Stainless steel	1
GU5410*PC	Polished chrome	1
GU5410WPW	Painted white with white interior	1
GU5410WPN	Pearl nickel with white interior	1
GU5410BBN	Black nickel with black interior	1
GU5410*PB	Polished brass	1
GU5410CLR	Transparent with white interior	1

- **Standard of compliance:** BS 1363
- **Mounting box:** 35mm deep (switched)
- **Fixing screws:** M3.5 x 25mm and 30mm
- **Plate dimensions:** 88 x 88mm

## 1 3A double-pole switched with neon



GU5411BSS

Product code	Description	Pack qty
GU5411*SS	Stainless steel	1
GU5411*PC	Polished chrome	1
GU5411WPW	Painted white with white interior	1
GU5411WPN	Pearl nickel with white interior	1
GU5411BBN	Black nickel with black interior	1
GU5411*PB	Polished brass	1
GU5411BBK	Piano black with black interior	1
GU5411WWH	Gloss white with white interior	1

## 1 3A double-pole switched with flex outlet



GU5413BSS

Product code	Description	Pack qty
GU5413*SS	Stainless steel	1
GU5413*PC	Polished chrome	1
GU5413WPW	Painted white with white interior	1
GU5413WPN	Pearl nickel with white interior	1
GU5413BBN	Black nickel with black interior	1
GU5413*PB	Polished brass	1

## 1 3A double-pole switched with neon and flex outlet



GU5414BSS

Product code	Description	Pack qty
GU5414*SS	Stainless steel	1
GU5414*PC	Polished chrome	1
GU5414WPW	Painted white with white interior	1
GU5414WPN	Pearl nickel with white interior	1
GU5414BBN	Black nickel with black interior	1
GU5414*PB	Polished brass	1



# High current switches

## 50A 2 gang double-pole switches



GU4421BSS

Product code	Description	Pack qty
GU4421*SS	Stainless steel	1
GU4421*PC	Polished chrome	1
GU4421WPW	Painted white with white interior	1
GU4421WPN	Pearl nickel with white interior	1
GU4421BBN	Black nickel with black interior	1
GU4421*PB	Polished brass	1

- **Standard of compliance:** BS EN 60669-1
- **Mounting box:** 47mm deep
- **Fixing screws:** M3.5 x 25mm and 30mm
- **Plate dimensions:** 148 x 88mm

## 45A double-pole cooker control unit with 1 3A switched socket & neons



GU4401BSS

Product code	Description	Pack qty
GU4401*SS	Stainless steel	1
GU4401*PC	Polished chrome	1
GU4401WPW	Painted white with white interior	1
GU4401WPN	Pearl nickel with white interior	1
GU4401BBN	Black nickel with black interior	1
GU4401*PB	Polished brass	1
GU4401BBK	Piano black with black interior	1
GU4401WWH	Gloss white with white interior	1

- **Standard of compliance:** BS 4177
- **Mounting box:** 47mm deep
- **Fixing screws:** M3.5 x 25mm and 30mm
- **Plate dimensions:** 88 x 148mm

# Shaver socket

## 115/230V dual voltage



GU7490BSS

Product code	Description	Pack qty
GU7490*SS	Stainless steel	1
GU7490*PC	Polished chrome	1
GU7490WPW	Painted white with white interior	1
GU7490WPN	Pearl nickel with white interior	1
GU7490BBN	Black nickel with black interior	1
GU7490*PB	Polished brass	1
GU7490BBK	Piano black with black interior	1
GU7490WWH	Gloss white with white interior	1

- **Standard of compliance:** BS EN 61558-2-5
- **Mounting box:** 47mm deep
- **Fixing screws:** M3.5 x 25mm and 30mm
- **Plate dimensions:** 148 x 88mm
- **Technical notes:** Unique design allows perfect fit to 47mm box.





# Telephone & Data Outlets

## Single RJ11



GU7451BSS

Product code	Description	Pack qty
GU7451*SS	Stainless steel	1
GU7451*PC	Polished chrome	1
GU7451WPW	Painted white with white interior	1
GU7451WPN	Pearl nickel with white interior	1
GU7451BBN	Black nickel with black interior	1
GU7451*PB	Polished brass	1

- **Standard of compliance:**  
BS EN 41003
- **Mounting box:**  
Minimum 25mm deep
- **Fixing screws:**  
M3.5 x 25mm and 30mm
- **Plate dimensions:**  
88 x 88mm
- **Technical notes:**  
Refer to Euro plates & modules section for combined telephone & data solutions.

## Master BT telephone



GU7461BSS

Product code	Description	Pack qty
GU7461*SS	Stainless steel	1
GU7461*PC	Polished chrome	1
GU7461WPW	Painted white with white interior	1
GU7461WPN	Pearl nickel with white interior	1
GU7461BBN	Black nickel with black interior	1
GU7461*PB	Polished brass	1
GU7461BBK	Piano black with black interior	1
GU7461WWH	Gloss white with white interior	1

## Secondary BT telephone



GU7462BSS

Product code	Description	Pack qty
GU7462*SS	Stainless steel	1
GU7462*PC	Polished chrome	1
GU7462WPW	Painted white with white interior	1
GU7462WPN	Pearl nickel with white interior	1
GU7462BBN	Black nickel with black interior	1
GU7462*PB	Polished brass	1
GU7462BBK	Piano black with black interior	1
GU7462WWH	Gloss white with white interior	1

## RJ45 CAT5e



GU7471BSS

Product code	Description	Pack qty
GU7471*SS	Stainless steel	1
GU7471*PC	Polished chrome	1
GU7471WPW	Painted white with white interior	1
GU7471WPN	Pearl nickel with white interior	1
GU7471BBN	Black nickel with black interior	1
GU7471*PB	Polished brass	1
GU7471BBK	Piano black with black interior	1
GU7471WWH	Gloss white with white interior	1

# TV outlets

## Single TV/FM



GU7410BSS

Product code	Description	Pack qty
GU7410*SS	Stainless steel	1
GU7410*PC	Polished chrome	1
GU7410WPW	Painted white with white interior	1
GU7410WP	Pearl nickel with white interior	1
GU7410BBN	Black nickel with black interior	1
GU7410*PB	Polished brass	1

- **Standard of compliance:** BS 3041 (where applicable)
- **Mounting box:** 25mm deep
- **Fixing screws:** M3.5 x 25mm and 30mm
- **Plate dimensions:** 88 x 88mm
- **Technical notes:** Products are direct connection and are not suitable for common connection

## Twin TV/FM



GU7420BSS

Product code	Description	Pack qty
GU7420*SS	Stainless steel	1
GU7420*PC	Polished chrome	1
GU7420WPW	Painted white with white interior	1
GU7420WPN	Pearl nickel with white interior	1
GU7420BBN	Black nickel with black interior	1
GU7420BBN	Polished brass	1

## Single SAT



GU7430BSS

Product code	Description	Pack qty
GU7430*SS	Stainless steel	1
GU7430*PC	Polished chrome	1
GU7430WPW	Painted white with white interior	1
GU7430WPN	Pearl nickel with white interior	1
GU7430BBN	Black nickel with black interior	1
GU7430*PB	Polished brass	1

# Euro modular plates & modules

## 1 gang euro plate, 1 module 25 x 50mm



GU8450SS

Product code	Description	Pack qty
GU8450SS	Stainless steel	1
GU8450PC	Polished chrome	1
GU8450PW	Painted white	1
GU8450PN	Pearl nickel	1
GU8450BN	Black nickel	1
GU8450PB	Polished brass	1

- **Mounting box:** Refer to module for appropriate mounting box depth
- **Plate dimensions:** 88 x 88mm (1 gang)
- **Technical notes:** Mounting grid supplied with euro plate.

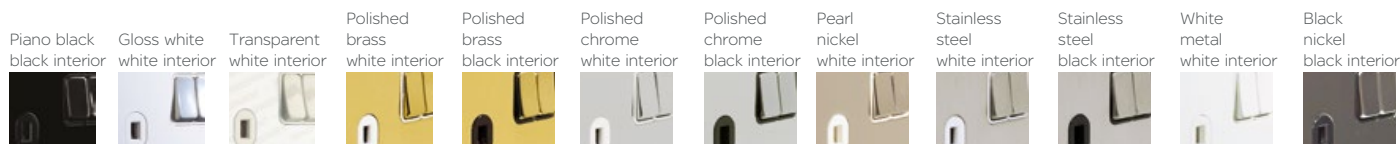

# Euro modular plates & modules continued

## 1 gang euro plate, 2 module 50 x 50mm



GU8460SS

Product code	Description	Pack qty
GU8460SS	Stainless steel	1
GU8460PC	Polished chrome	1
GU8460PW	Painted white	1
GU8460PN	Pearl nickel	1
GU8460BN	Black nickel	1
GU8460PB	Polished brass	1

- **Mounting box:**  
Refer to module for appropriate mounting box depth
- **Plate dimensions:**  
88 x 88mm (1 gang)  
88 x 148mm (2 gang)
- **Technical notes:**  
Mounting grid supplied with euro plate.

## 2 gang euro plate, 4 module 100 x 50mm



GU8480SS

Product code	Description	Pack qty
GU8480SS	Stainless steel	1
GU8480PC	Polished chrome	1
GU8480PW	Painted white	1
GU8480PN	Pearl nickel	1
GU8480BN	Black nickel	1
GU8480PB	Polished brass	1

## 25 x 50mm euro modules



GUE7073B



GUE7072W



GUE7061B

Product code	Description	Pack qty
GUE7011*	Single IEC coax (female)	1
GUE7012*	25 x 50mm euro modules IEC coax (male)	1
GUE7030*	Single F type sat	1
GUE7061*	BT master telephone	1
GUE7062*	BT secondary telephone	1
GUE7071*	RJ45 CAT5e (not screened)	1
GUE7072*	RJ45 CAT6 (not screened)	1
GUE7073*	Single USB charger 1A 5Vdc	1
GUE7051*	RJ11 modem	1
GUE7075*	VGA	1
GUE7091*	LexCom Performance outlet	8
GUE7000*	2 x Phono socket	1
GUE7001*	2 x Loudspeaker socket	1
GUE8010*	Blank module	5

- **Mounting box:**  
25mm deep (25 x 50mm modules)
- **Euro module dimensions:**  
25 x 50mm (single)

## 50 x 50mm euro modules



GUE7020B



GUE7081W



GUE7010B

Product code	Description	Pack qty
GUE7010*	TV/FM diplexer	1
GUE7040*	TV/Sat diplexer	1
GUE7074*	Twin USB charger 2 x 1A 5Vdc	1
GUE7081*	TV/FM/Sat triplexer	1
GUE7082*	TV/FM/Sat1/Sat2 quadplexer	1
GUE7020*	HDMI	1

- **Mounting box:**  
35mm deep (50 x 50mm modules)
- **Euro module dimensions:**  
50 x 50mm (double)

# Blank plates & accessories

## 1 gang

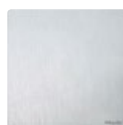

GU8410SS

Product code	Description	Pack qty
GU8410SS	Stainless steel	1
GU8410PC	Polished chrome	1
GU8410PW	Painted white	1
GU8410PN	Pearl nickel	1
GU8410BN	Black nickel	1
GU8410PB	Polished brass	1

- **Standard of compliance:**  
BS 5733
- **Fixing screws:**  
M3.5 x 25mm and 30mm
- **Plate dimensions:**  
88 x 88mm (1 gang)  
88 x 148mm (2 gang)

## 2 gang



GU8420SS

Product code	Description	Pack qty
GU8420SS	Stainless steel	1
GU8420PC	Polished chrome	1
GU8420PW	Painted white	1
GU8420PN	Pearl nickel	1
GU8420BN	Black nickel	1
GU8420PB	Polished brass	1
3746130	M3.5 x 25mm raised head machine screws	100
USCREW50SS	M3.5 x 50mm screws	100

# Grid plates

## 1 gang 88 x 88mm



GUGS01GSS

Product code	Description	Pack qty
GUGS01GSS	Stainless steel	1
GUGS01GMS	Mirror steel	1
GUGS01GPW	Painted white	1
GUGS01GPN	Pearl nickel	1
GUGS01GBN	Black nickel	1
GUGS01GPB	Polished brass	1
GBG01	76 x 76 x 42mm back box	1

- **Mounting box:**  
42mm deep
- **Technical notes:**  
All grid plates are supplied with the appropriate number of mounting frames.

Mirror steel used for polished chrome grid plates & modules.

## 2 gang 88 x 88mm



GUGS02GSS

Product code	Description	Pack qty
GUGS02GSS	Stainless steel	1
GUGS02GMS	Mirror steel	1
GUGS02GPW	Painted white	1
GUGS02GPN	Pearl nickel	1
GUGS02GBN	Black nickel	1
GUGS02GPB	Polished brass	1
GBG01	76 x 76 x 42mm back box	1

## Grid plates continued

### 3 gang 88 x 148mm



GUGS03GSS

Product code	Description	Pack qty
GUGS03GSS	Stainless steel	1
GUGS03GMS	Mirror steel	1
GUGS03GPW	Painted white	1
GUGS03GPN	Pearl nickel	1
GUGS03GBN	Black nickel	1
GUGS03GPB	Polished brass	1
GBG02	136 x 76 x 42mm back box	1

- **Mounting box:**  
42mm deep
- **Technical notes:**  
All grid plates are supplied with the appropriate number of mounting frames.

Mirror steel used for polished chrome grid plates & modules.

### 4 gang 88 x 148mm



GUGS04GSS

Product code	Description	Pack qty
GUGS04GSS	Stainless steel	1
GUGS04GMS	Mirror steel	1
GUGS04GPW	Painted white	1
GUGS04GPN	Pearl nickel	1
GUGS04GBN	Black nickel	1
GUGS04GPB	Polished brass	1
GBG02	136 x 76 x 42mm back box	1

### 6 gang 156 x 156mm



GUGS06SS

Product code	Description	Pack qty
GUGS06GSS	Stainless steel	1
GUGS06GMS	Mirror steel	1
GUGS06GPW	Painted white	1
GUGS06GPN	Pearl nickel	1
GUGS06GBN	Black nickel	1
GUGS06GPB	Polished brass	1
GBG03	136 x 136 x 42mm back box	1

### 8 gang 156 x 156mm



GUGS08GSS

Product code	Description	Pack qty
GUGS08GSS	Stainless steel	1
GUGS08GMS	Mirror steel	1
GUGS08GPW	Painted white	1
GUGS08GPN	Pearl nickel	1
GUGS08GBN	Black nickel	1
GUGS08GPB	Polished brass	1
GBG03	136 x 136 x 42mm back box	1

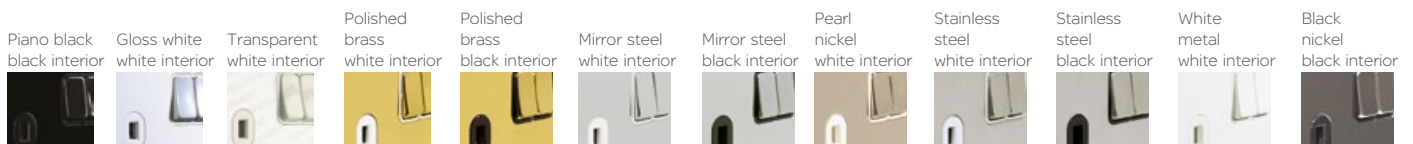

## Grid plates continued

### 9 gang 216 x 156mm

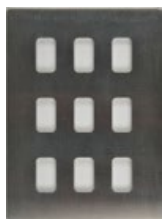

GUGS09GSS

Product code	Description	Pack qty
GUGS09GSS	Stainless steel	1
GUGS09GMS	Mirror steel	1
GUGS09GPW	Painted white	1
GUGS09GPN	Pearl nickel	1
GUGS09GBN	Black nickel	1
GUGS09GPB	Polished brass	1
GBG04F	193 x 133 x 42mm back box	1

- **Mounting box:**  
42mm deep
- **Technical notes:**  
All grid plates are supplied with the appropriate number of mounting frames.

Mirror steel used for polished chrome grid plates & modules.

### 12 gang 216 x 156mm

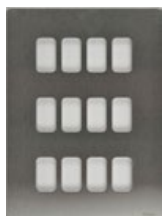

GUGS12GSS

Product code	Description	Pack qty
GUGS12GSS	Stainless steel	1
GUGS12GMS	Mirror steel	1
GUGS12GPW	Painted white	1
GUGS12GPN	Pearl nickel	1
GUGS12GBN	Black nickel	1
GUGS12GPB	Polished brass	1
GBG04F	193 x 133 x 42mm back box	1

### 18 gang 398 x 156mm



GUGS18GSS

Product code	Description	Pack qty
GUGS18GSS	Stainless steel	1
GUGS18GMS	Mirror steel	1
GUGS18GPW	Painted white	1
GUGS18GPN	Pearl nickel	1
GUGS18GBN	Black nickel	1
GUGS18GPB	Polished brass	1
GBG06F	374 x 133 x 42mm back box	1

### 24 gang 398 x 156mm



GUGS24GSS

Product code	Description	Pack qty
GUGS24GSS	Stainless steel	1
GUGS24GMS	Mirror steel	1
GUGS24GPW	Painted white	1
GUGS24GPN	Pearl nickel	1
GUGS24GBN	Black nickel	1
GUGS24GPB	Polished brass	1
GBG06F	374 x 133 x 42mm back box	1

# Customisable switch grid modules

10AX metal switch module components (white or black surrounds)



GUG102MB GUG101MW

Product code	Description	Pack qty
GUG101M*	10AX 1 way SP	1
GUG102M*	10AX 2 way SP	1
GUG101M*	10AX intermediate SP	1

- **Standard of compliance:** BS EN 60669-1
- **Mounting box:** 42mm deep
- **Technical notes:** 10AX & 20AX metal switch module components available in black or white.
- Clear terminal marking printed onto grey switch module component back mouldings ensures easy identification.
- Pre-printed rocker caps
- Easy assembly

20AX metal switch module components (white or black surrounds)



GUG2020MB GUG20DPMW

Product code	Description	Pack qty
GUG201M*	20AX 1 way SP	1
GUG2020M*	20AX 2 way and off SP	1
GUG202M*	20AX 2 way SP	1
GUG20DPM*	20AX DP	1

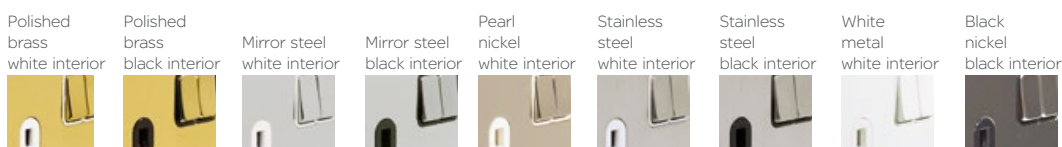
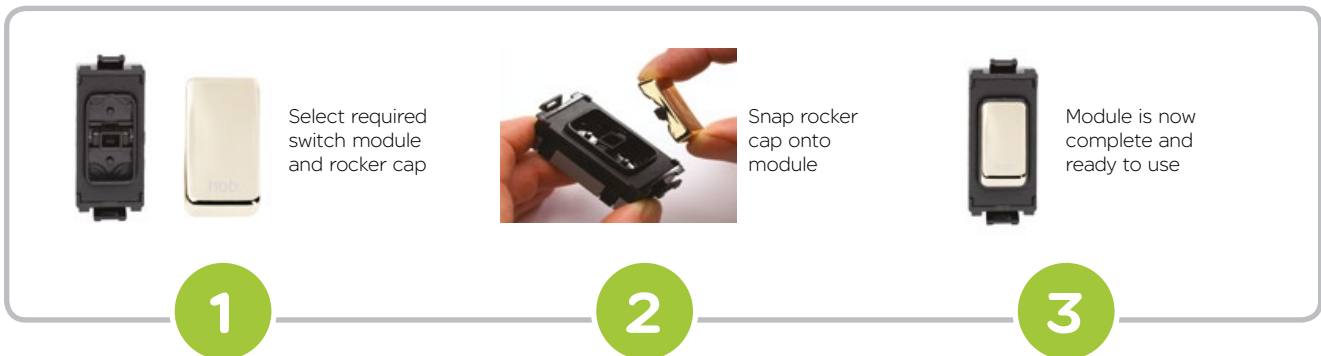

## Plain and printed rocker caps for component modules



	Stainless Steel	Mirror Steel	Polished Brass	Pearl Nickel	Painted White	Black Nickel	Painted Black
Plain rocker cap	GUGRSS	GUGRMS	GUGRPB	GUGRPN	GUGRPW	GUGRBN	GUGRBLK
Rocker cap printed boiler	GUGRBOSS	GUGRBOMS	GUGRBOPB	GUGRBOPN	GUGRBOPW	GUGRBOBN	GUGRBOBLK
Rocker cap printed cooker hood	GUGRCHSS	GUGRCHMS	GUGRCHPB	GUGRCHPN	GUGRCHPW	GUGRCHBN	GUGRCHBLK
Rocker cap printed dish washer	GUGRDWSS	GUGRDWMS	GUGRDWPB	GUGRDWPN	GUGRDWPW	GUGRDWBN	GUGRDWBLK
Rocker cap printed extractor fan	GUGREFSS	GUGREFMS	GUGREFPB	GUGREFPN	GUGREFPW	GUGREFBN	GUGREFBLK
Rocker cap printed fridge	GUGFRSS	GUGFRMS	GUGFRPB	GUGFRPN	GUGFRPW	GUGFRBN	GUGFRBLK
Rocker cap printed fan	GUGRFSS	GUGRFMS	GUGRFPB	GUGRFPN	GUGRFPW	GUGRFBN	GUGRFBLK
Rocker cap printed freezer	GUGRFZSS	GUGRFZMS	GUGRFZPB	GUGRFZPN	GUGRFZPW	GUGRFZBN	GUGRFZBLK
Rocker cap printed fridge/freezer	GUGRFRZSS	GUGRFRZMS	GUGRFRZPB	GUGRFRZPN	GUGRFRZPW	GUGRFRZBN	GUGRFRZBLK
Rocker cap printed hob	GUGRHSS	GUGRHMS	GUGRHOPB	GUGRHOPN	GUGRHOPW	GUGRHOBN	GUGRHOBK
Rocker cap printed heater	GUGRHSS	GUGRHMS	GUGRHEPB	GUGRHEPN	GUGRHEPW	GUGRHEBN	GUGRHEBLK
Rocker cap printed microwave	GUGRMWSS	GUGRMWMS	GUGRMWPB	GUGRMWPN	GUGRMWPW	GUGRMWBN	GUGRMWBLK
Rocker cap printed oven	GUGROVSS	GUGROVMS	GUGROVPB	GUGROVPN	GUGROVPW	GUGROVBN	GUGROVBLK
Rocker cap printed tumble dryer	GUGRTDSS	GUGRTDMS	GUGRTDPB	GUGRTDPN	GUGRTDPW	GUGRTDBN	GUGRTDBLK
Rocker cap printed washer dryer	GUGRWDYSS	GUGRWDYMS	GUGRWDYPB	GUGRWDYPN	GUGRWDYPW	GUGRWDYBN	GUGRWDYBLK
Rocker cap printed waste disposal	GUGRWDSS	GUGRWDMS	GUGRWDPB	GUGRWDPN	GUGRWDPW	GUGRWDNB	GUGRWDNBK
Rocker cap printed washing machine	GUGRWMSS	GUGRWMMS	GUGRWMPB	GUGRWMPN	GUGRWMPW	GUGRWMBN	GUGRWMBLK

## Retractive & toggle switch grid modules

6AX 2 way retractive and centre off



GUG2020CBSS

Product code	Description	Pack qty
GUG2020C*SS	Stainless steel	1
GUG2020C*MS	Mirror steel	1
GUG2020CWPW	Painted white with white interior	1
GUG2020CWPN	Pearl nickel with white interior	1
GUG2020CBBN	Black nickel with black interior	1
GUG2020C*PB	Polished brass	1

- **Standard of compliance:** BS EN 60669-1
- **Mounting box:** 42mm deep
- **Technical notes:** Mirror steel used for polished chrome grid plates & modules.

6AX 2 way and centre off



GUG2020BSS

Product code	Description	Pack qty
GUG2020*SS	Stainless steel	1
GUG2020*MS	Mirror steel	1
GUG2020WPW	Painted white with white interior	1
GUG2020WPN	Pearl nickel with white interior	1
GUG2020BBN	Black nickel with black interior	1
GUG2020*PB	Polished brass	1



# Retractive & toggle switch grid modules continued

## 10AX 2 way retractive single-pole



GUG102RBSS

Product code	Description	Pack qty
GUG102R*SS	Stainless steel	1
GUG102R*MS	Mirror steel	1
GUG102RWPW	Painted white with white interior	1
GUG102RWPN	Pearl nickel with white interior	1
GUG102RBBN	Black nickel with black interior	1
GUG102R*PB	Polished brass	1

- **Standard of compliance:**  
BS EN 60669-1
- **Mounting box:**  
42mm deep
- **Technical notes:**  
Mirror steel used for polished chrome grid plates & modules.

## 10AX 2 way single-pole toggle



GUG102TBSS

Product code	Description	Pack qty
GUG102T*SS	Stainless steel	1
GUG102T*MS	Mirror steel	1
GUG102TWPW	Painted white with white interior	1
GUG102TWPN	Pearl nickel with white interior	1
GUG102TBBN	Black nickel with black interior	1
GUG102T*PB	Polished brass	1

## 10AX intermediate toggle



GUG10ITBSS

Product code	Description	Pack qty
GUG10IT*SS	Stainless steel	1
GUG10IT*MS	Mirror steel	1
GUG10ITWPW	Painted white with white interior	1
GUG10ITWPN	Pearl nickel with white interior	1
GUG10ITBBN	Black nickel with black interior	1
GUG10IT*PB	Polished brass	1

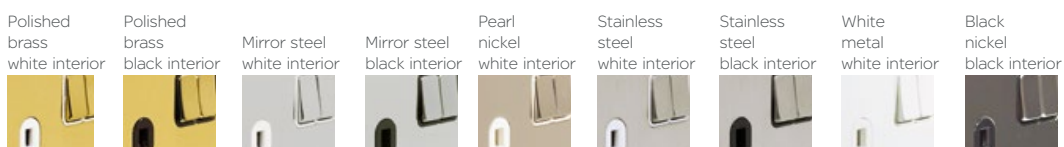

# Key switch grid modules

## 20AX 1 way key operated double-pole



GUG20DPKBSS

Product code	Description	Pack qty
GUG20DPK*SS	Stainless steel	1
GUG20DPK*MS	Mirror steel	1
GUG20DPKWPW	Painted white with white interior	1
GUG20DPKWPN	Pearl nickel with white interior	1
GUG20DPKBBN	Black nickel with black interior	1
GUG20DPK*PB	Polished brass	1

- **Standard of compliance:** BS EN 60669-1
- **Mounting box:** 42mm deep
- **Technical notes:** Mirror steel used for polished chrome grid plates & modules.

## 20AX 2 way key operated



GUG202KBSS

Product code	Description	Pack qty
GUG202K*SS	Stainless steel	1
GUG202K*MS	Mirror steel	1
GUG202KWPW	Painted white with white interior	1
GUG202KWPN	Pearl nickel with white interior	1
GUG202KBBN	Black nickel with black interior	1
GUG202K*PB	Polished brass	1

## 20AX 2 way key operated printed red TEST EMG LTG



GUG202KELBSS

Product code	Description	Pack qty
GUG202KEL*SS	Stainless steel	1
GUG202KEL*MS	Mirror steel	1
GUG202KELWPW	Painted white with white interior	1
GUG202KELWPN	Pearl nickel with white interior	1
GUG202KELBBN	Black nickel with black interior	1
GUG202KEL*PB	Polished brass	1

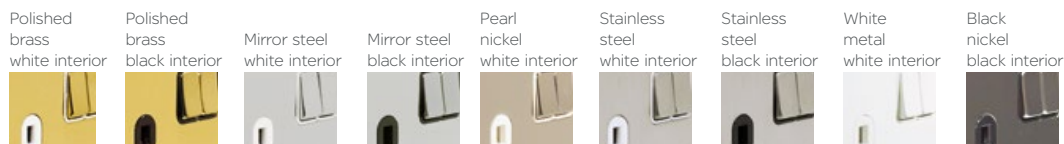

# Telephone grid modules

## BT master telephone



GUGTELMBSS

Product code	Description	Pack qty
GUGTELM*SS	Stainless steel	1
GUGTELM*MS	Mirror steel	1
GUGTELMWPW	Painted white with white interior	1
GUGTELMWPN	Pearl nickel with white interior	1
GUGTELMBBN	Black nickel with black interior	1
GUGTELM*PB	Polished brass	1

- **Standard of compliance:** BS EN 3041 (where applicable)
- **Mounting box:** 42mm deep
- **Technical notes:** Mirror steel used for polished chrome grid plates & modules.

## BT secondary telephone



GUGTELSBSS

Product code	Description	Pack qty
GUGTELS*SS	Stainless steel	1
GUGTELS*MS	Mirror steel	1
GUGTELSWPW	Painted white with white interior	1
GUGTELSWPN	Pearl nickel with white interior	1
GUGTELSBBN	Black nickel with black interior	1
GUGTELS*PB	Polished brass	1

## RJ11 telephone



GUGRJ11BSS

Product code	Description	Pack qty
GUGRJ11*SS	Stainless steel	1
GUGRJ11*MS	Mirror steel	1
GUGRJ11WPW	Painted white with white interior	1
GUGRJ11WPN	Pearl nickel with white interior	1
GUGRJ11BBN	Black nickel with black interior	1
GUGRJ11*PB	Polished brass	1

## Data & TV grid modules

### RJ45 CAT5e



GUGRJ45BSS

Product code	Description	Pack qty
GUGRJ45*SS	Stainless steel	1
GUGRJ45*MS	Mirror steel	1
GUGRJ45WPW	Painted white with white interior	1
GUGRJ45WPN	Pearl nickel with white interior	1
GUGRJ45BBN	Black nickel with black interior	1
GUGRJ45*PB	Polished brass	1

- **Standard of compliance:** BS EN 3041 (where applicable)
- **Mounting box:** 42mm deep
- **Technical notes:** Mirror steel used for polished chrome grid plates & modules.

### Direct coaxial TV



GUGCOBSS

Product code	Description	Pack qty
GUGCO*SS	Stainless steel	1
GUGCO*MS	Mirror steel	1
GUGCOWPW	Painted white with white interior	1
GUGCOWPN	Pearl nickel with white interior	1
GUGCOBBN	Black nickel with black interior	1
GUGCO*PB	Polished brass	1

### F type satellite



GUGSATBSS

Product code	Description	Pack qty
GUGSAT*SS	Stainless steel	1
GUGSAT*MS	Mirror steel	1
GUGSATWPW	Painted white with white interior	1
GUGSATWPN	Pearl nickel with white interior	1
GUGSATBBN	Black nickel with black interior	1
GUGSAT*PB	Polished brass	1

## Electronic dimmer grid modules

### 300W/VA universal multiway touch dimmer module



GUGEMDIMBSS16

Product code	Description	Pack qty
GUGEMDIM*SS16	Stainless steel	1
GUGEMDIM*MS16	Mirror steel	1
GUGEMDIMWPW16	Painted white with white interior	1
GUGEMDIMWPN16	Pearl nickel with white interior	1
GUGEMDIMBBN16	Black nickel with black interior	1
GUGEMDIM*PB16	Polished brass	1

- **Mounting box:** 42mm deep
- **Technical notes:** Min load 60W/50VA.

Mirror steel used for polished chrome grid plates & modules.

### 300W/VA universal multiway touch dimmer module with infra red remote option



GUGEMRDIMB16

Product code	Description	Pack qty
GUGEMRDIMW16	White moulded	1
GUGEMRDIMB16	Black moulded	1
GU6000RC1	1 channel IR remote control	1

Electronic modules are capable of 2 way or multiway dimming.

- Retractive switch for use with electronic dimmers only.
- Not compatible with moulded grid plates.
- Modules will require derating when used in multi-gang applications.

# Electronic dimmer grid modules continued

50mA 2 way & multiway retractive switch module



GUGEMWBSS

Product code	Description	Pack qty
GUGEMW*SS	Stainless steel	1
GUGEMW*MS	Mirror steel	1
GUGEMWWPW	Painted white with white interior	1
GUGEMWWPN	Pearl nickel with white interior	1
GUGEMWBBN	Black nickel with black interior	1
GUGEMW*PB	Polished brass	1

# Fuse carrier, flex outlet & blank grid modules

1 3A fuse carrier



GUG13FCUBSS

Product code	Description	Pack qty
GUG13FCU*SS	Stainless steel	1
GUG13FCU*MS	Mirror steel	1
GUG13FCUWPW	Painted white with white interior	1
GUG13FCUWPN	Pearl nickel with white interior	1
GUG13FCUBBN	Black nickel with black interior	1
GUG13FCU*PB	Polished brass	1

- **Standard of compliance:**  
BS 1363 (fuse carrier)  
BS 5733
- **Mounting box:**  
42mm deep
- **Technical notes:**  
Full metal surround on all modules  
Modules are completely interchangeable

Flex outlet up to 10mm ø



GUG16COBSS

Product code	Description	Pack qty
GUG16CO*SS	Stainless steel	1
GUG16CO*MS	Mirror steel	1
GUG16COWPW	Painted white with white interior	1
GUG16COWPN	Pearl nickel with white interior	1
GUG16COBBN	Black nickel with black interior	1
GUG16CO*PB	Polished brass	1

Mirror steel used for polished chrome grid plates & modules.

Blank



GUGBBSS

Product code	Description	Pack qty
GUGB*SS	Stainless steel	1
GUGB*MS	Mirror steel	1
GUGBWPW	Painted white with white interior	1
GUGBWPN	Pearl nickel with white interior	1
GUGBBBN	Black nickel with black interior	1
GUGB*PB	Polished brass	1
GUGB*	Moulded plastic (black or white)	1

Polished brass  
white interior



Polished brass  
black interior



Mirror steel  
white interior



Mirror steel  
black interior



Pearl nickel  
white interior



Stainless steel  
white interior



Stainless steel  
black interior

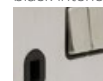

White metal  
white interior



Black nickel  
black interior

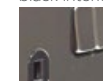

# Indicator modules

## White surround



Product code	Description	Pack qty
GUGINDWG	Green indicator	1
GUGINDWR	Red indicator	1
GUGINDWO	Orange indicator	1

- **Standard of compliance:** BS 5733
- **Technical notes:** 240V

## Black surround



Product code	Description	Pack qty
GUGINDBG	Green indicator	1
GUGINDBR	Red indicator	1
GUGINDBO	Orange indicator	1

# Flush galvanised steel boxes

## 16mm deep



Product code	Description	Pack qty
SB161	1 gang	20

- **Standard of compliance:** BS4662
- **Technical notes:** Supplied with earth terminal and screw.

## 25mm deep



Product code	Description	Pack qty
SB251	1 gang	10
SB252	2 gang	10

Supplied with fixed and adjustable lugs.

Fitted with selection of 20mm knockouts in sides and back.

## 35mm deep



Product code	Description	Pack qty
SB351	1 gang	10
SB352	2 gang	5

# Flush galvanised steel boxes continued

47mm deep



SB472

Product code	Description	Pack qty
SB471	1 gang	10
SB472	2 gang	4

- **Standard of compliance:**  
BS4662

- **Technical notes:**  
Supplied with earth terminal and screw.

Supplied with fixed and adjustable lugs.

Fitted with selection of 20mm knockouts in sides and back.

# ULTIMATE Flat Plate

Combining superior engineering with urban style, Ultimate Flat Plate utilises the aesthetics and functions of the Ultimate range, with an ultra slim 1.5mm thick front plate. With complementary finishes numerous aspects to make installation easier, flat plate is a firm favourite of consumers and electrical contractors alike.

Available in a choice of six high quality finishes with black or white interior options – coordinating these accessories has never been easier.

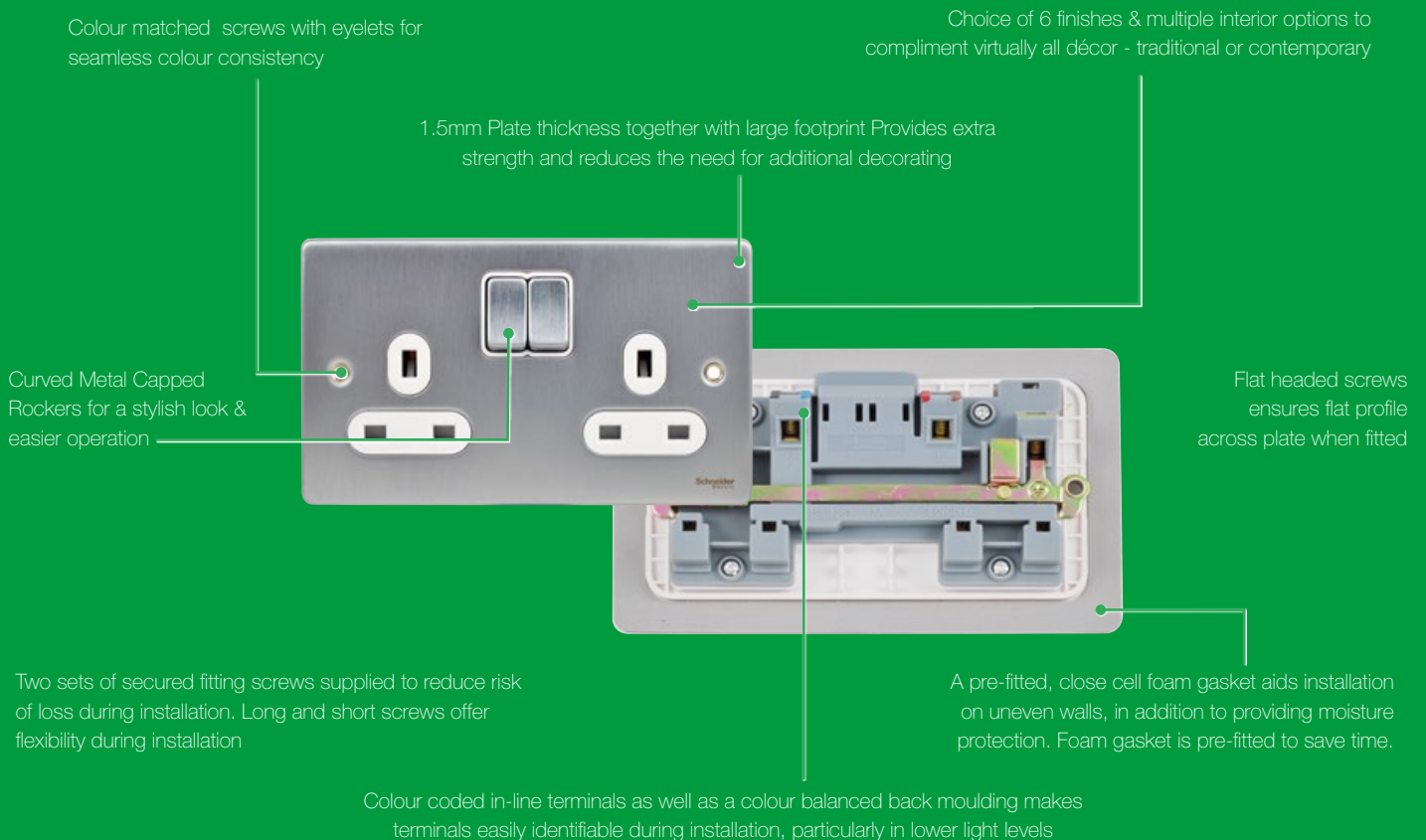

## Specification Highlights:



13A Floor Sockets offer additional flexibility and easier power accessibility for residential and commercial floor plans



Outboard Sockets provide a practical solution for improved visibility and ease of operation



Control energy access an improve public safety in communal areas with non standard sockets,



A complete range of 2A, 5A, and 15A round pin sockets outlets to support bespoke lighting designs.

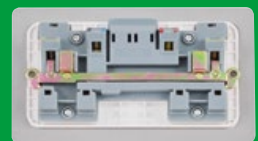

Twin earth terminals on 2 gang sockets enable installation in areas requiring high integrity earthing



ULTIMATE  
FLAT PLATE



# Socket outlets

## 1 3A 1 gang unswitched



GU3250WPC

Product code	Description	Pack qty
GU3250*SS	Stainless steel	1
GU3250*PC	Polished chrome	1
GU3250WPW	Painted white with white interior	1
GU3250WPN	Pearl nickel with white interior	1
GU3250BBN	Black nickel with black interior	1
GU3250*PB	Polished brass	1

- **Standard of compliance:** BS 1363 (13A)
- **Mounting box:** Minimum 25mm deep
- **Fixing screws:** M3.5 x 25mm and 30mm
- **Plate dimensions:** 88 x 88mm (1 gang)  
88 x 148mm (2 gang)

## 1 3A 2 gang unswitched



GU3260WPC

Product code	Description	Pack qty
GU3260*SS	Stainless steel	1
GU3260*PC	Polished chrome	1
GU3260WPW	Painted white with white interior	1
GU3260WPN	Pearl nickel with white interior	1
GU3260BBN	Black nickel with black interior	1
GU3260*PB	Polished brass	1

- **Technical notes:** All 2 gang sockets supplied with twin earth terminals as standard. To aid flush installation, 35mm steel boxes are recommended (BS7671).

## 1 3A 1 gang single-pole switched



GU3210WPC

Product code	Description	Pack qty
GU3210*SS	Stainless steel	1
GU3210*PC	Polished chrome	1
GU3210WPW	Painted white with white interior	1
GU3210WPN	Pearl nickel with white interior	1
GU3210BBN	Black nickel with black interior	1
GU3210*PB	Polished brass	1

## 1 3A 1 gang double-pole switched



GU3210DWPC

Product code	Description	Pack qty
GU3210D*SS	Stainless steel	1
GU3210D*PC	Polished chrome	1
GU3210DWPW	Painted white with white interior	1
GU3210DWPN	Pearl nickel with white interior	1
GU3210DBBN	Black nickel with black interior	1
GU3210D*PB	Polished brass	1

## 1 3A 2 gang single-pole switched



GU3220WPC

Product code	Description	Pack qty
GU3220*SS	Stainless steel	1
GU3220*PC	Polished chrome	1
GU3220WPW	Painted white with white interior	1
GU3220WPN	Pearl nickel with white interior	1
GU3220BBN	Black nickel with black interior	1
GU3220*PB	Polished brass	1

# Socket outlets continued

## 1 3A 2 gang double-pole switched

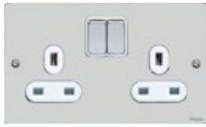

GU3220DWPC

Product code	Description	Pack qty
GU3220D*SS	Stainless steel	1
GU3220D*PC	Polished chrome	1
GU3220DWPW	Painted white with white interior	1
GU3220DWPN	Pearl nickel with white interior	1
GU3220DBBN	Black nickel with black interior	1
GU3220D*PB	Polished brass	1

- **Standard of compliance:** BS 1363 (13A)
- **Mounting box:** Minimum 25mm deep
- **Fixing screws:** M3.5 x 25mm and 30mm
- **Plate dimensions:** 88 x 88mm (1 gang)  
88 x 148mm (2 gang)
- **Technical notes:** All 2 gang sockets supplied with twin earth terminals as standard. To aid flush installation, 35mm steel boxes are recommended (BS7671).
- Floor socket interiors are manufactured from high impact thermoplastic for strength.

## 1 3A 2 gang double-pole switched with clean earth & outboard rockers



GU3231WPC

Product code	Description	Pack qty
GU3231*SS	Stainless steel	1
GU3231*PC	Polished chrome	1
GU3231WPW	Painted white	1
GU3231BBN	Black nickel	1

## 1 3A 2 gang double-pole switched with clean earth & outboard rockers



GU3234WPC

Product code	Description	Pack qty
GU3234*SS	Stainless steel	1
GU3234WPC	Polished chrome	1

## 1 3A 1 gang unswitched floor socket



GU3251WSS

Product code	Description	Pack qty
GU3251*SS	Stainless steel	1
GU3251*PC	Polished chrome	1
GU3251WPW	Painted white with white interior	1
GU3251WPN	Pearl nickel with white interior	1
GU3251BBN	Black nickel with black interior	1
GU3251*PB	Polished brass	1

## 1 3A 2 gang unswitched floor socket



GU3252WPC

Product code	Description	Pack qty
GU3252*SS	Stainless steel	1
GU3252*PC	Polished chrome	1
GU3252WPW	Painted white with white interior	1
GU3252WPN	Pearl nickel with white interior	1
GU3252BBN	Black nickel with black interior	1
GU3252*PB	Polished brass	1

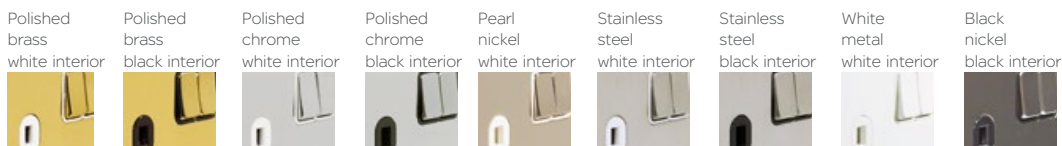

## Socket outlets continued

### 2A unswitched round pin



GU3270WPC

Product code	Description	Pack qty
GU3270*SS	Stainless steel	1
GU3270*PC	Polished chrome	1
GU3270*PW	Painted white with white interior	1
GU3270WPN	Pearl nickel with white interior	1
GU3270BBN	Black nickel with black interior	1
GU3270*PB	Polished brass	1

- **Standard of compliance:** BS 546 (round pin)
- **Mounting box:** Minimum 25mm deep
- **Fixing screws:** M3.5 x 25mm and 30mm
- **Plate dimensions:** 86 x 86mm (1 gang)

### 5A unswitched round pin



GU3280WPC

Product code	Description	Pack qty
GU3280*SS	Stainless steel	1
GU3280*PC	Polished chrome	1
GU3280*PW	Painted white with white interior	1
GU3280WPN	Pearl nickel with white interior	1
GU3280BBN	Black nickel with black interior	1
GU3280*PB	Polished brass	1

### 15A unswitched round pin



GU3290WPC

Product code	Description	Pack qty
GU3290*SS	Stainless steel	1
GU3290*PC	Polished chrome	1
GU3290*PW	Painted white with white interior	1
GU3290WPN	Pearl nickel with white interior	1
GU3290BBN	Black nickel with black interior	1
GU3290*PB	Polished brass	1

## Media plates

### Stacked with 2 x 2 gang double-pole socket outlets & 4 x 2 module euro



GU32204DMPWPC

Product code	Description	Pack qty
GU32204DMP*SS	Stainless steel	1
GU32204DMP*PC	Polished chrome	1
GU32204DMPWPW	Painted white with white interior	1
GU32204DMPWPN	Pearl nickel with white interior	1
GU32204DMPBBN	Black nickel with black interior	1
GU32204DMP*PB	Polished brass	1
GGBSB4724M	Stacked back box	1

- **Standard of compliance:** BS 5733 BS 1363-2
- **Mounting box:** 47mm deep
- **Fixing screws:** M3.5 x 25mm and 30mm
- **Plate dimensions:** 296 x 88mm (in-line)

### In-line with 2 gang double-pole socket outlets & 2 x 2 module euro



GU32202DMPWPC

Product code	Description	Pack qty
GU32202DMP*SS	Stainless steel	1
GU32202DMP*PC	Polished chrome	1
GU32202DMPWPW	Painted white with white interior	1
GU32202DMPWPN	Pearl nickel with white interior	1
GU32202DMPBBN	Black nickel with black interior	1
GU32202DMP*PB	Polished brass	1
GGBSB4722M	In-line back box	1

# Plate switches

## 16AX 1 gang 2 way



GU1212WPC

Product code	Description	Pack qty
GU1212*SS	Stainless steel	1
GU1212*PC	Polished chrome	1
GU1212*PW	Painted white with white interior	1
GU1212WPN	Pearl nickel with white interior	1
GU1212BBN	Black nickel with black interior	1
GU1212*PB	Polished brass	1

- **Standard of compliance:**  
BS EN 60669-1
- **Mounting box:**  
16mm deep (1-2 gang)  
25mm deep (3-6 gang)
- **Fixing screws:**  
M3.5 x 25mm and  
30mm
- **Plate dimensions:**  
88 x 88mm (1-3 gang),  
88 x 148mm (4-6 gang)

## 16AX 1 gang intermediate



GU1214WPC

Product code	Description	Pack qty
GU1214*SS	Stainless steel	1
GU1214*PC	Polished chrome	1
GU1214*PW	Painted white with white interior	1
GU1214WPN	Pearl nickel with white interior	1
GU1214BBN	Black nickel with black interior	1
GU1214*PB	Polished brass	1

## 16A 1 gang 2 way retractive



GU1212RWPC

Product code	Description	Pack qty
GU1212R*SS	Stainless steel	1
GU1212R*PC	Polished chrome	1
GU1212R*PW	Painted white with white interior	1
GU1212RWPN	Pearl nickel with white interior	1
GU1212RBBN	Black nickel with black interior	1
GU1212R*PB	Polished brass	1

## 16AX 2 gang 2 way



GU1222WPC

Product code	Description	Pack qty
GU1222*SS	Stainless steel	1
GU1222*PC	Polished chrome	1
GU1222*PW	Painted white with white interior	1
GU1222WPN	Pearl nickel with white interior	1
GU1222BBN	Black nickel with black interior	1
GU1222*PB	Polished brass	1

## 16AX 3 gang 2 way



GU1232WPC

Product code	Description	Pack qty
GU1232*SS	Stainless steel	1
GU1232*PC	Polished chrome	1
GU1232*PW	Painted white with white interior	1
GU1232WPN	Pearl nickel with white interior	1
GU1232BBN	Black nickel with black interior	1
GU1232*PB	Polished brass	1

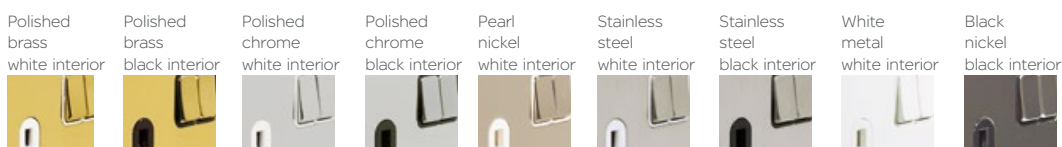

## Plate switches continued

### 16AX 4 gang 2 way



GU1242WPC

Product code	Description	Pack qty
GU1242*SS	Stainless steel	1
GU1242*PC	Polished chrome	1
GU1242*PW	Painted white with white interior	1
GU1242WPN	Pearl nickel with white interior	1
GU1242BBN	Black nickel with black interior	1
GU1242*PB	Polished brass	1

- **Standard of compliance:**  
BS EN 60669-1  
BS EN 60947-3  
(GU1213\*\*\*)
- **Mounting box:**  
16mm deep (1-2 gang)  
25mm deep (3-6 gang)
- **Fixing screws:**  
M3.5 x 25mm and  
30mm
- **Plate dimensions:**  
88 x 88mm (1-3 gang),  
88 x 148mm (4-6 gang)

### 16AX 6 gang 2 way



GU1262WPC

Product code	Description	Pack qty
GU1262*SS	Stainless steel	1
GU1262*PC	Polished chrome	1
GU1262*PW	Painted white with white interior	1
GU1262WPN	Pearl nickel with white interior	1
GU1262BBN	Black nickel with black interior	1
GU1262*PB	Polished brass	1

### 10A triple pole isolator



GU1213WPC

Product code	Description	Pack qty
GU1213*SS	Stainless steel	1
GU1213*PC	Polished chrome	1
GU1213*PW	Painted white with white interior	1
GU1213WPN	Pearl nickel with white interior	1
GU1213BBN	Black nickel with black interior	1
GU1213*PB	Polished brass	1

## Toggle switches

### 16AX 1 gang 2 way



GU1212TPB

Product code	Description	Pack qty
GU1212TSS	Stainless steel	1
GU1212TPC	Polished chrome	1
GU1212TPW	Painted white	1
GU1212TPN	Pearl nickel	1
GU1212TBN	Black nickel	1
GU1212TPB	Polished brass	1

- **Standard of compliance:**  
BS EN 60669-1
- **Mounting box:**  
16mm deep (1-2 gang)  
25mm deep (3-4 gang)
- **Fixing screws:**  
M3.5 x 25mm and  
30mm
- **Plate dimensions:**  
88 x 88mm (1-3 gang)  
88 x 148mm (4 gang)

### 16AX 2 gang 2 way



GU1222TPC

Product code	Description	Pack qty
GU1222TSS	Stainless steel	1
GU1222TPC	Polished chrome	1
GU1222TPW	Painted white	1
GU1222TPN	Pearl nickel	1
GU1222TBN	Black nickel	1
GU1222TPB	Polished brass	1

# Toggle switches continued

## 1 6AX 3 gang 2 way



GU1232TPC

Product code	Description	Pack qty
GU1232TSS	Stainless steel	1
GU1232TPC	Polished chrome	1
GU1232TPW	Painted white	1
GU1232TPN	Pearl nickel	1
GU1232TBN	Black nickel	1
GU1232TPB	Polished brass	1

- **Standard of compliance:** BS EN 60669-1
- **Mounting box:** 25mm deep (3-4 gang)
- **Fixing screws:** M3.5 x 25mm and 30mm
- **Plate dimensions:** 88 x 88mm (1-3 gang) 88 x 148mm (4 gang)

## 1 6AX 4 gang 2 way



GU1242TPB

Product code	Description	Pack qty
GU1242TSS	Stainless steel	1
GU1242TPC	Polished chrome	1
GU1242TPW	Painted white	1
GU1242TPN	Pearl nickel	1
GU1242TBN	Black nickel	1
GU1242TPB	Polished brass	1

# Dimmer switches

## 1 gang 2 way 400W/VA mains & low voltage



GU6212PC

Product code	Description	Pack qty
GU6212CSS	Stainless steel	1
GU6212CPC	Polished chrome	1
GU6212CPW	Painted white	1
GU6212CPN	Pearl nickel	1
GU6212CBN	Black nickel	1
GU6212CPB	Polished brass	1

- **Standard of compliance:** BS EN 60669-2-1
- **Mounting box:** 25mm deep (1-2 gang) 35mm deep (3-4 gang)
- **Fixing screws:** M3.5 x 25mm and 30mm
- **Plate dimensions:** 88 x 88mm (1-2 gang) 88 x 148mm (3-4 gang)

## 2 gang 2 way 250W/VA mains & low voltage



GU6222CPC

Product code	Description	Pack qty
GU6222CSS	Stainless steel	1
GU6222CPC	Polished chrome	1
GU6222CPW	Painted white	1
GU6222CPN	Pearl nickel	1
GU6222CBN	Black nickel	1
GU6222CPB	Polished brass	1

- **Technical notes:** All dimmers not suitable with CFL lighting.

Mains & low voltage and electronic dimmers not suitable for use with LED lamps.

Mains & low voltage dimmers - leading edge control.

LED dimmers - trailing edge control.

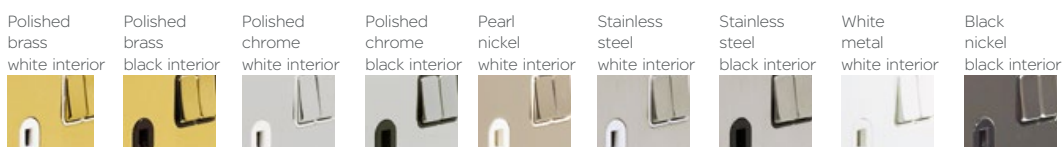

## Dimmer switches continued

### 3 gang 2 way 250W/VA mains & low voltage



GU6232CPC

Product code	Description	Pack qty
GU6232CSS	Stainless steel	1
GU6232CPC	Polished chrome	1
GU6232CPW	Painted white	1
GU6232CPN	Pearl nickel	1
GU6232CBN	Black nickel	1
GU6232CPB	Polished brass	1

- **Standard of compliance:**  
BS EN 60669-2-1
- **Mounting box:**  
25mm deep (1-2 gang)  
35mm deep (3-4 gang)
- **Fixing screws:**  
M3.5 x 25mm and  
30mm
- **Plate dimensions:**  
88 x 88mm (1-2 gang)  
88 x 148mm (3-4 gang)

### 4 gang 2 way 250W/VA mains & low voltage



GU6242CPC

Product code	Description	Pack qty
GU6242CSS	Stainless steel	1
GU6242CPC	Polished chrome	1
GU6242CPW	Painted white	1
GU6242CPN	Pearl nickel	1
GU6242CBN	Black nickel	1
GU6242CPB	Polished brass	1

- **Technical notes:**  
All dimmers not suitable  
with CFL lighting.

Mains & low voltage and  
electronic dimmers not  
suitable for use with LED  
lamps.

Mains & low voltage  
dimmers - leading edge  
control.

LED dimmers - trailing  
edge control.

### 1 gang 2 way 100W/VA LED



GU6212LPC

Product code	Description	Pack qty
GU6212LSS	Stainless steel	1
GU6212LPC	Polished chrome	1
GU6212LPW	Painted white	1
GU6212LPN	Pearl nickel	1
GU6212LBN	Black nickel	1
GU6212LPB	Polished brass	1

### 2 gang 2 way 100W/VA LED



GU6222LPC

Product code	Description	Pack qty
GU6222LSS	Stainless steel	1
GU6222LPC	Polished chrome	1
GU6222LPW	Painted white	1
GU6222LPN	Pearl nickel	1
GU6222LBN	Black nickel	1
GU6222LPB	Polished brass	1

### 3 gang 2 way 75W/VA LED



GU6232LPC

Product code	Description	Pack qty
GU6232LSS	Stainless steel	1
GU6232LPC	Polished chrome	1
GU6232LPW	Painted white	1
GU6232LPN	Pearl nickel	1
GU6232LBN	Black nickel	1
GU6232LPB	Polished brass	1



# Dimmer switches continued

## 4 gang 2 way 75W/VA LED



GU6242LPC

Product code	Description	Pack qty
GU6242LSS	Stainless steel	1
GU6242LPC	Polished chrome	1
GU6242LPW	Painted white	1
GU6242LPN	Pearl nickel	1
GU6242LBN	Black nickel	1
GU6242LPB	Polished brass	1

- **Standard of compliance:**  
BS EN 60669-2-1
- **Mounting box:**  
16mm deep (1-2 gang)  
35mm deep (3-4 gang)
- **Fixing screws:**  
M3.5 x 25mm and 30mm
- **Plate dimensions:**  
86 x 86mm (1-2 gang)  
88 x 148mm (3-4 gang)
- **Technical notes:**  
All dimmers not suitable for use with CFL lighting.

## 1 gang 2 way 300W/VA electronic



GU6212EWPC

Product code	Description	Pack qty
GU6212E*SS	Stainless steel	1
GU6212E*PC	Polished chrome	1
GU6212EWPW	Painted white with white interior	1
GU6212EWPN	Pearl nickel with white interior	1
GU6212EBBN	Black nickel with black interior	1
GU6212E*PB	Polished brass	1

Mains & low voltage and electronic dimmers not suitable for use with LED lamps.

Mains & low voltage dimmers - leading edge control.

LED dimmers - trailing edge control.

## 2 gang 2 way 200W/VA electronic



GU6222EWPC

Product code	Description	Pack qty
GU6222E*SS	Stainless steel	1
GU6222E*PC	Polished chrome	1
GU6222EWPW	Painted white with white interior	1
GU6222EWPN	Pearl nickel with white interior	1
GU6222EBBN	Black nickel with black interior	1
GU6222E*PB	Polished brass	1

## 1 gang 2 way 300W/VA IR electronic



GU6212RWPC

Product code	Description	Pack qty
GU6212R*SS	Stainless steel	1
GU6212R*PC	Polished chrome	1
GU6212RWPW	Painted white with white interior	1
GU6212RWPN	Pearl nickel with white interior	1
GU6212RBBN	Black nickel with black interior	1
GU6212R*PB	Polished brass	1
GU6000RC1	1 channel IR remote control	1

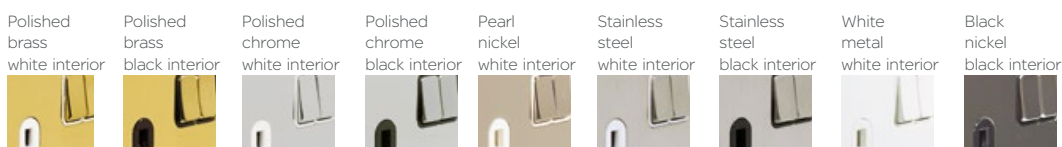

# Control switches

## 20AX double-pole 1 gang



GU2210WPC

Product code	Description	Pack qty
GU2210*SS	Stainless steel	1
GU2210*PC	Polished chrome	1
GU2210WPW	Painted white with white interior	1
GU2210WPN	Pearl nickel with white interior	1
GU2210BBN	Black nickel with black interior	1
GU2210*PB	Polished brass	1

- **Standard of compliance:** BS EN 60669-1 (switches)
- **Mounting box:** 35mm deep
- **Fixing screws:** M3.5 x 25mm and 30mm
- **Plate dimensions:** 88 x 88mm

## 20AX double-pole 1 gang with neon



GU2211WPC

Product code	Description	Pack qty
GU2211*SS	Stainless steel	1
GU2211*PC	Polished chrome	1
GU2211WPW	Painted white with white interior	1
GU2211WPN	Pearl nickel with white interior	1
GU2211BBN	Black nickel with black interior	1
GU2211*PB	Polished brass	1

## 20AX double-pole 1 gang with flex outlet



GU2213WPC

Product code	Description	Pack qty
GU2213*SS	Stainless steel	1
GU2213*PC	Polished chrome	1
GU2213WPW	Painted white with white interior	1
GU2213WPN	Pearl nickel with white interior	1
GU2213BBN	Black nickel with black interior	1
GU2213*PB	Polished brass	1

## 20AX double-pole 1 gang with neon & flex outlet



GU2214WPC

Product code	Description	Pack qty
GU2214*SS	Stainless steel	1
GU2214*PC	Polished chrome	1
GU2214WPW	Painted white with white interior	1
GU2214WPN	Pearl nickel with white interior	1
GU2214BBN	Black nickel with black interior	1
GU2214*PB	Polished brass	1

## 20AX double-pole 1 gang with neon & flex outlet printed water heater



GU2214WHWPC

Product code	Description	Pack qty
GU2214WH*SS	Stainless steel	1
GU2214WH*PC	Polished chrome	1
GU2214WHWPW	Painted white with white interior	1
GU2214WHWPN	Pearl nickel with white interior	1
GU2214WHBBN	Black nickel with black interior	1
GU2214WH*PB	Polished brass	1

## 32A double-pole 1 gang with neon



GU4231WPC

Product code	Description	Pack qty
GU4231*SS	Stainless steel	1
GU4231*PC	Polished chrome	1
GU4231WPW	Painted white with white interior	1
GU4231WPN	Pearl nickel with white interior	1
GU4231BBN	Black nickel with black interior	1
GU4231*PB	Polished brass	1

# Fused connection units

## 1 3A unswitched



GU5200WPC

Product code	Description	Pack qty
GU5200*SS	Stainless steel	1
GU5200*PC	Polished chrome	1
GU5200WPW	Painted white with white interior	1
GU5200WPN	Pearl nickel with white interior	1
GU5200BBN	Black nickel with black interior	1
GU5200*PB	Polished brass	1

- **Standard of compliance:** BS 1363
- **Mounting box:** 25mm deep (unswitched) 35mm deep (switched)
- **Fixing screws:** M3.5 x 25mm and 30mm
- **Plate dimensions:** 88 x 88mm

## 1 3A unswitched with flex outlet



GU5203WPC

Product code	Description	Pack qty
GU5203*SS	Stainless steel	1
GU5203*PC	Polished chrome	1
GU5203WPW	Painted white with white interior	1
GU5203WPN	Pearl nickel with white interior	1
GU5203BBN	Black nickel with black interior	1
GU5203*PB	Polished brass	1

## 1 3A double-pole switched



GU5210WPC

Product code	Description	Pack qty
GU5210*SS	Stainless steel	1
GU5210*PC	Polished chrome	1
GU5210WPW	Painted white with white interior	1
GU5210WPN	Pearl nickel with white interior	1
GU5210BBN	Black nickel with black interior	1
GU5210*PB	Polished brass	1

## 1 3A double-pole switched with neon



GU5211WPC

Product code	Description	Pack qty
GU5211*SS	Stainless steel	1
GU5211*PC	Polished chrome	1
GU5211WPW	Painted white with white interior	1
GU5211WPN	Pearl nickel with white interior	1
GU5211BBN	Black nickel with black interior	1
GU5211*PB	Polished brass	1

## 1 3A double-pole switched with flex outlet



GU5213WPC

Product code	Description	Pack qty
GU5213*SS	Stainless steel	1
GU5213*PC	Polished chrome	1
GU5213WPW	Painted white with white interior	1
GU5213WPN	Pearl nickel with white interior	1
GU5213BBN	Black nickel with black interior	1
GU5213*PB	Polished brass	1

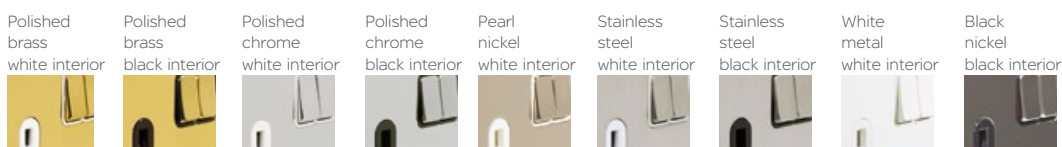

## Fused connection units continued

1 3A double-pole switched with neon & flex outlet



GU5214WPC

Product code	Description	Pack qty
GU5214*SS	Stainless steel	1
GU5214*PC	Polished chrome	1
GU5214WPW	Painted white with white interior	1
GU5214WPN	Pearl nickel with white interior	1
GU5214BBN	Black nickel with black interior	1
GU5214*PB	Polished brass	1

- **Standard of compliance:** BS 1363
- **Mounting box:** 25mm deep (unswitched)  
35mm deep (switched)
- **Fixing screws:** M3.5 x 25mm and 30mm
- **Plate dimensions:** 88 x 88mm

## High current switches

50A 2 gang double-pole switches with neon



GU4221WPC

Product code	Description	Pack qty
GU4221*SS	Stainless steel	1
GU4221*PC	Polished chrome	1
GU4221WPW	Painted white with white interior	1
GU4221WPN	Pearl nickel with white interior	1
GU4221BBN	Black nickel with black interior	1
GU4221*PB	Polished brass	1

- **Standard of compliance:** BS EN 60669-1 (switches)  
BS 4177 (cooker control units)
- **Mounting box:** 47mm deep
- **Fixing screws:** M3.5 x 25mm and 30mm
- **Plate dimensions:** 148 x 88mm (switches),  
88 x 148mm (cooker control units)

45A double-pole cooker control unit with 1 3A switched socket & neons



GU4201WPC

Product code	Description	Pack qty
GU4201*SS	Stainless steel	1
GU4201*PC	Polished chrome	1
GU4201WPW	Painted white with white interior	1
GU4201WPN	Pearl nickel with white interior	1
GU4201BBN	Black nickel with black interior	1
GU4201*PB	Polished brass	1

## Shaver socket

115/230V dual voltage



GU7290WPC

Product code	Description	Pack qty
GU7290*SS	Stainless steel	1
GU7290*PC	Polished chrome	1
GU7290WPW	Painted white with white interior	1
GU7290WPN	Pearl nickel with white interior	1
GU7290BBN	Black nickel with black interior	1
GU7290*PB	Polished brass	1

- **Standard of compliance:** BS EN 61558-2-5
- **Mounting box:** 47mm deep
- **Fixing screws:** M3.5 x 25mm and 30mm
- **Plate dimensions:** 148 x 88mm
- **Technical notes:** Unique design allows perfect fit to 47mm box.

# Telephone outlets

## Single RJ11



GU7251WPC

Product code	Description	Pack qty
GU7251*SS	Stainless steel	1
GU7251*PC	Polished chrome	1
GU7251WPW	Painted white with white interior	1
GU7251WPN	Pearl nickel with white interior	1
GU7251BBN	Black nickel with black interior	1
GU7251*PB	Polished brass	1

- **Standard of compliance:** BS EN 41003
- **Mounting box:** Minimum 25mm deep
- **Fixing screws:** M3.5 x 25mm and 30mm
- **Plate dimensions:** 88 x 88mm
- **Technical notes:** Refer to euro plates and modules section for combined telephone & data solutions.

## Master BT telephone



GU7261WPC

Product code	Description	Pack qty
GU7261*SS	Stainless steel	1
GU7261*PC	Polished chrome	1
GU7261WPW	Painted white with white interior	1
GU7261WPN	Pearl nickel with white interior	1
GU7261BBN	Black nickel with black interior	1
GU7261*PB	Polished brass	1

## Secondary BT telephone



GU7262WPC

Product code	Description	Pack qty
GU7262*SS	Stainless steel	1
GU7262*PC	Polished chrome	1
GU7262WPW	Painted white with white interior	1
GU7262WPN	Pearl nickel with white interior	1
GU7262BBN	Black nickel with black interior	1
GU7262*PB	Polished brass	1

# Data outlets

## RJ45 CAT5e



GU7271WPC

Product code	Description	Pack qty
GU7271*SS	Stainless steel	1
GU7271*PC	Polished chrome	1
GU7271WPW	Painted white with white interior	1
GU7271WPN	Pearl nickel with white interior	1
GU7271BBN	Black nickel with black interior	1
GU7271*PB	Polished brass	1

- **Standard of compliance:** BS EN 41003
- **Mounting box:** Minimum 25mm deep
- **Fixing screws:** M3.5 x 25mm and 30mm
- **Plate dimensions:** 88 x 88mm
- **Technical notes:** Refer to euro plates and modules section for combined telephone & data solutions.

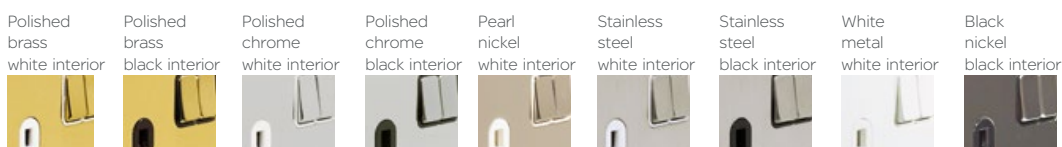

## TV outlets

### Single TV/FM



GU7210WPC

Product code	Description	Pack qty
GU7210*SS	Stainless steel	1
GU7210*PC	Polished chrome	1
GU7210WPW	Painted white with white interior	1
GU7210WPN	Pearl nickel with white interior	1
GU7210BBN	Black nickel with black interior	1
GU7210*PB	Polished brass	1

- **Standard of compliance:** BS 3041 (where applicable)
- **Mounting box:** 35mm deep
- **Fixing screws:** M3.5 x 25mm and 30mm
- **Plate dimensions:** 88 x 88mm
- **Technical notes:** Products are direct connection and are not suitable for common connection

### Twin TV/FM



GU7220WPC

Product code	Description	Pack qty
GU7220*SS	Stainless steel	1
GU7220*PC	Polished chrome	1
GU7220WPW	Painted white with white interior	1
GU7220WPN	Pearl nickel with white interior	1
GU7220BBN	Black nickel with black interior	1
GU7220*PB	Polished brass	1

### Single Satellite



GU7230WPC

Product code	Description	Pack qty
GU7230*SS	Stainless steel	1
GU7230*PC	Polished chrome	1
GU7230WPW	Painted white with white interior	1
GU7230WPN	Pearl nickel with white interior	1
GU7230BBN	Black nickel with black interior	1
GU7230*PB	Polished brass	1

## Euro modular plates & modules

### 1 gang euro plate, 1 module 25 x 50mm



GU8250PC

Product code	Description	Pack qty
GU8250SS	Stainless steel	1
GU8250PC	Polished chrome	1
GU8250PW	Painted white	1
GU8250PN	Pearl nickel	1
GU8250BN	Black nickel	1
GU8250PB	Polished brass	1

- **Mounting box:** Refer to module for appropriate mounting box depth
- **Plate dimensions:** 88 x 88mm (1 gang)
- **Technical notes:** Mounting grid supplied with euro plate.

### 1 gang euro plate, 2 module 50 x 50mm



GU8260PC

Product code	Description	Pack qty
GU8260SS	Stainless steel	1
GU8260PC	Polished chrome	1
GU8260PW	Painted white	1
GU8260PN	Pearl nickel	1
GU8260BN	Black nickel	1
GU8260PB	Polished brass	1

# Euro modular plates & modules continued

2 gang euro plate, 4 module 100 x 50mm



GU8280PC

Product code	Description	Pack qty
GU8280SS	Stainless steel	1
GU8280PC	Polished chrome	1
GU8280PW	Painted white	1
GU8280PN	Pearl nickel	1
GU8280BN	Black nickel	1
GU8280PB	Polished brass	1

- **Mounting box:** Refer to module for appropriate mounting box depth
- **Plate dimensions:** 88 x 148mm (2 gang)
- **Technical notes:** Mounting grid supplied with euro plate.

25 x 50mm euro modules



GUE7073B GUE7072W



GUE7061B

Product code	Description	Pack qty
GUE7011*	Single IEC coax (female)	1
GUE7012*	Single IEC coax (male)	1
GUE7030*	Single F type sat	1
GUE7061*	BT master telephone	1
GUE7062*	BT secondary telephone	1
GUE7071*	RJ45 CAT5e (not screened)	1
GUE7072*	RJ45 CAT6 (not screened)	1
GUE7073*	Single USB charger 1A 5Vdc	1
GUE7051*	RJ11 modem	1
GUE7075*	VGA	1
GUE7091*	LexCom Performance outlet	8
GUE7000*	2 x Phono socket	1
GUE7001*	2 x Loudspeaker socket	1
GUE8010*	Blank module	5

- **Mounting box:** 25mm deep (25 x 50mm modules)
- **Euro module dimensions:** 25 x 50mm (single)

50 x 50mm euro modules



GUE7020B GUE7082W

Product code	Description	Pack qty
GUE7010*	TV/FM diplexer	1
GUE7040*	TV/Sat diplexer	1
GUE7074*	Twin USB charger 2 x 1A 5Vdc	1
GUE7081*	TV/FM/Sat triplexer	1
GUE7082*	TV/FM/Sat1/Sat2 quadplexer	1
GUE7020*	HDMI	1

- **Mounting box:** 35mm deep (50 x 50mm modules)
- **Euro module dimensions:** 50 x 50mm (double)

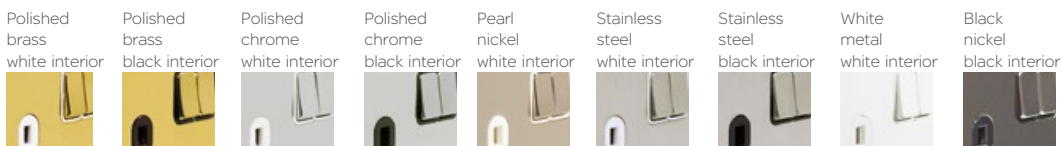

# Blank plates & accessories

## 1 gang



GU8210PC

Product code	Description	Pack qty
GU8210SS	Stainless steel	1
GU8210PC	Polished chrome	1
GU8210PW	Painted white	1
GU8210PN	Pearl nickel	1
GU8210BN	Black nickel	1
GU8210PB	Polished brass	1

- **Standard of compliance:** BS 5733
- **Fixing screws:** M3.5 x 25mm and 30mm
- **Plate dimensions:** 88 x 88mm (1 gang)  
88 x 148mm (2 gang)

## 2 gang

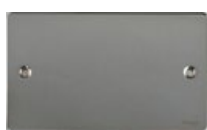

GU8220PC

Product code	Description	Pack qty
GU8220SS	Stainless steel	1
GU8220PC	Polished chrome	1
GU8220PW	Painted white	1
GU8220PN	Pearl nickel	1
GU8220BN	Black nickel	1
GU8220PB	Polished brass	1
3746130	M3.5 x 25mm raised head machine screws	100
USCREW50SS	M3.5 x 50mm screws	100

# Grid plates

## 1 gang 88 x 88mm

Product code	Description	Pack qty
GUG01GSS	Stainless steel	1
GUG01GMS	Mirror steel	1
GUG01GPW	Painted white	1
GUG01GPN	Pearl nickel	1
GUG01GBN	Black nickel	1
GUG01GPB	Polished brass	1
GBG01	76 x 76 x 42mm back box	1

- **Mounting box:** 42mm deep
- **Technical notes:** All grid plates are supplied with the appropriate number of mounting frames.  
Mirror steel used for polished chrome grid plates & modules.

## 2 gang 88 x 88mm



GUG02GMS

Product code	Description	Pack qty
GUG02GSS	Stainless steel	1
GUG02GMS	Mirror steel	1
GUG02GPW	Painted white	1
GUG02GPN	Pearl nickel	1
GUG02GBN	Black nickel	1
GUG02GPB	Polished brass	1
GBG01	76 x 76 x 42mm back box	1

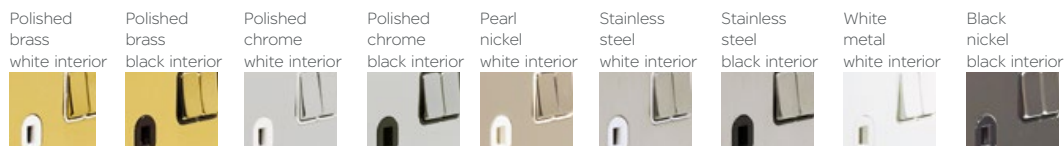



## Grid plates continued

### 3 gang 88 x 148mm



GUG03GMS

Product code	Description	Pack qty
GUG03GSS	Stainless steel	1
GUG03GMS	Mirror steel	1
GUG03GPW	Painted white	1
GUG03GPN	Pearl nickel	1
GUG03GBN	Black nickel	1
GUG03GPB	Polished brass	1
GBG02	136 x 76 x 42mm back box	1

- **Mounting box:**  
42mm deep

- **Technical notes:**  
All grid plates are supplied with the appropriate number of mounting frames.

Mirror steel used for polished chrome grid plates & modules.

### 4 gang 88 x 148mm



GUG04GMS

Product code	Description	Pack qty
GUG04GSS	Stainless steel	1
GUG04GMS	Mirror steel	1
GUG04GPW	Painted white	1
GUG04GPN	Pearl nickel	1
GUG04GBN	Black nickel	1
GUG04GPB	Polished brass	1
GBG02	136 x 76 x 42mm back box	1

### 6 gang 156 x 156mm



GUG06GMS

Product code	Description	Pack qty
GUG06GSS	Stainless steel	1
GUG06GMS	Mirror steel	1
GUG06GPW	Painted white	1
GUG06GPN	Pearl nickel	1
GUG06GBN	Black nickel	1
GUG06GPB	Polished brass	1
GBG03	136 x 136 x 42mm back box	1

### 8 gang 156 x 156mm



GUG08GMS

Product code	Description	Pack qty
GUG08GSS	Stainless steel	1
GUG08GMS	Mirror steel	1
GUG08GPW	Painted white	1
GUG08GPN	Pearl nickel	1
GUG08GBN	Black nickel	1
GUG08GPB	Polished brass	1
GBG03	136 x 136 x 42mm back box	1

### 9 gang 216 x 156mm



GUG09GMS

Product code	Description	Pack qty
GUG09GSS	Stainless steel	1
GUG09GMS	Mirror steel	1
GUG09GPW	Painted white	1
GUG09GPN	Pearl nickel	1
GUG09GBN	Black nickel	1
GUG09GPB	Polished brass	1
GBG04F	193 x 133 x 42mm back box	1

## Grid plates continued

### 12 gang 216 x 156mm



GUG12GMS

Product code	Description	Pack qty
GUG12GSS	Stainless steel	1
GUG12GMS	Mirror steel	1
GUG12GPW	Painted white	1
GUG12GPN	Pearl nickel	1
GUG12GBN	Black nickel	1
GUG12GPB	Polished brass	1
GBG04F	193 x 133 x 42mm back box	1

- **Mounting box:**  
42mm deep

- **Technical notes:**  
All grid plates are supplied with the appropriate number of mounting frames.

Mirror steel used for polished chrome grid plates & modules.

### 18 gang 398 x 156mm



GUG18GMS

Product code	Description	Pack qty
GUG18GSS	Stainless steel	1
GUG18GMS	Mirror steel	1
GUG18GPW	Painted white	1
GUG18GPN	Pearl nickel	1
GUG18GBN	Black nickel	1
GUG18GPB	Polished brass	1
GBG06F	374 x 133 x 42mm back box	1

### 24 gang 398 x 156mm



GUG24GMS

Product code	Description	Pack qty
GUG24GSS	Stainless steel	1
GUG24GMS	Mirror steel	1
GUG24GPW	Painted white	1
GUG24GPN	Pearl nickel	1
GUG24GBN	Black nickel	1
GUG24GPB	Polished brass	1
GBG06F	374 x 133 x 42mm back box	1

# Customisable switch grid modules

10AX metal switch module components (white or black surrounds)



GUG102MB GUG101MW

Product code	Description	Pack qty
GUG101M*	10AX 1 way SP	1
GUG102M*	10AX 2 way SP	1
GUG101M*	10AX intermediate SP	1

- **Standard of compliance:** BS EN 60669-1
- **Mounting box:** 42mm deep
- **Technical notes:** 10AX & 20AX metal switch module components available in black or white.
- Clear terminal marking printed onto grey switch module component back mouldings ensures easy identification.
- Pre-printed rocker caps
- Easy assembly

20AX metal switch module components (white or black surrounds)



GUG2020MB GUG20DPMW

Product code	Description	Pack qty
GUG201M*	20AX 1 way SP	1
GUG2020M*	20AX 2 way and off SP	1
GUG202M*	20AX 2 way SP	1
GUG20DPM*	20AX DP	1

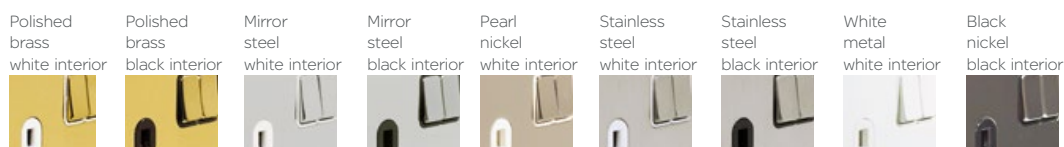
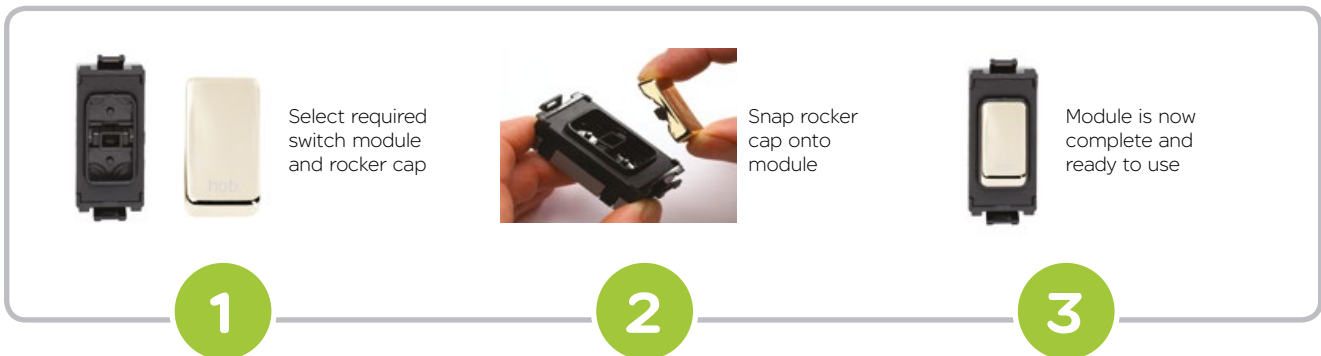

# Plain and printed rocker caps for component modules



	Stainless Steel	Mirror Steel	Polished Brass	Pearl Nickel	Painted White	Black Nickel	Painted Black
<b>Plain rocker cap</b>	GUGRSS	GUGRMS	GUGRPB	GUGRPN	GUGRPW	GUGRBN	GUGRBLK
<b>Rocker cap printed boiler</b>	GUGRBOSS	GUGRBOMS	GUGRBOPB	GUGRBOPN	GUGRBOPW	GUGRBOBN	GUGRBOBLK
<b>Rocker cap printed cooker hood</b>	GUGRCHSS	GUGRCHMS	GUGRCHPB	GUGRCHPN	GUGRCHPW	GUGRCHBN	GUGRCHBLK
<b>Rocker cap printed dish washer</b>	GUGRDWSS	GUGRDWMS	GUGRDWPB	GUGRDWPN	GUGRDWPW	GUGRDWBN	GUGRDWBLK
<b>Rocker cap printed extractor fan</b>	GUGREFSS	GUGREFMS	GUGREFPB	GUGREFPN	GUGREFPW	GUGREFBN	GUGREFBLK
<b>Rocker cap printed fridge</b>	GUGRFRSS	GUGRFRMS	GUGRFRPB	GUGRFRPN	GUGRFRPW	GUGRFRBN	GUGRFRBLK
<b>Rocker cap printed fan</b>	GUGRFASS	GUGRFAMS	GUGRFAPB	GUGRFAPN	GUGRFAPW	GUGRFABN	GUGRFABLK
<b>Rocker cap printed freezer</b>	GUGRFZSS	GUGRFZMS	GUGRFZPB	GUGRFZPN	GUGRFZPW	GUGRFZBN	GUGRFZBLK
<b>Rocker cap printed fridge/freezer</b>	GUGRFRFZSS	GUGRFRFZMS	GUGRFRFZPB	GUGRFRFZPN	GUGRFRFZPW	GUGRFRFZBN	GUGRFRFZBLK
<b>Rocker cap printed hob</b>	GUGRHOSS	GUGRHOMS	GUGRHOPB	GUGRHOPN	GUGRHOPW	GUGRHOBN	GUGRHOBK
<b>Rocker cap printed heater</b>	GUGRHESS	GUGRHEMS	GUGRHEPB	GUGRHEPN	GUGRHEPW	GUGRHEBN	GUGRHEBLK
<b>Rocker cap printed microwave</b>	GUGRMWSS	GUGRMWMS	GUGRMWPB	GUGRMWPN	GUGRMWPW	GUGRMWBN	GUGRMWBLK
<b>Rocker cap printed oven</b>	GUGROVSS	GUGROVMS	GUGROVPB	GUGROVPN	GUGROVPW	GUGROVBN	GUGROVBLK
<b>Rocker cap printed tumble dryer</b>	GUGRTDSS	GUGRTDMS	GUGRTDPB	GUGRTDPN	GUGRTDPW	GUGRTDBN	GUGRTDBLK
<b>Rocker cap printed washer dryer</b>	GUGRWDYSS	GUGRWDYMS	GUGRWDYPB	GUGRWDYPN	GUGRWDYPW	GUGRWDYBN	GUGRWDYBLK
<b>Rocker cap printed waste disposal</b>	GUGRWDSS	GUGRWDMS	GUGRWDPB	GUGRWDPN	GUGRWDPW	GUGRWDNB	GUGRWDNBK
<b>Rocker cap printed washing machine</b>	GUGRWMSS	GUGRWMMS	GUGRWMWPB	GUGRWMWPN	GUGRWMWPW	GUGRWMWBN	GUGRWMWBLK

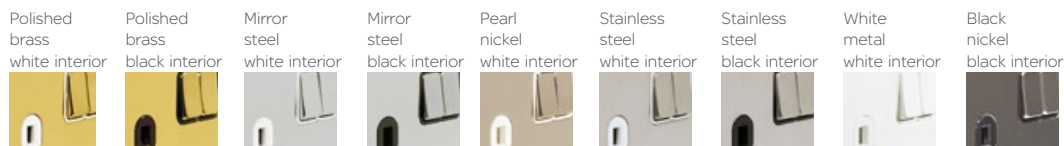

# Retractive & toggle switch grid modules

## 6AX 2 way retractive and centre off



GUG202OCWMS

Product code	Description	Pack qty
GUG202OC*SS	Stainless steel	1
GUG202OC*MS	Mirror steel	1
GUG202OCWPPW	Painted white with white interior	1
GUG202OCWPPN	Pearl nickel with white interior	1
GUG202OCBBN	Black nickel with black interior	1
GUG202OC*PB	Polished brass	1

- **Standard of compliance:**  
BS EN 60669-1
- **Mounting box:**  
42mm deep
- **Technical notes:**  
Mirror steel used for polished chrome grid plates & modules.

## 6AX 2 way and centre off



GUG102RWMS

Product code	Description	Pack qty
GUG2020*SS	Stainless steel	1
GUG2020*MS	Mirror steel	1
GUG2020WPPW	Painted white with white interior	1
GUG2020WPPN	Pearl nickel with white interior	1
GUG2020BBN	Black nickel with black interior	1
GUG2020*PB	Polished brass	1

## 1 OAX 2 way retractive single-pole



GUG102TWMS

Product code	Description	Pack qty
GUG102R*SS	Stainless steel	1
GUG102R*MS	Mirror steel	1
GUG102RPPW	Painted white with white interior	1
GUG102RPPN	Pearl nickel with white interior	1
GUG102RBBN	Black nickel with black interior	1
GUG102R*PB	Polished brass	1

## 1 OAX 2 way single-pole toggle



GUG102TWMS

Product code	Description	Pack qty
GUG102T*SS	Stainless steel	1
GUG102T*MS	Mirror steel	1
GUG102TWPW	Painted white with white interior	1
GUG102TWPN	Pearl nickel with white interior	1
GUG102TBBN	Black nickel with black interior	1
GUG102T*PB	Polished brass	1

## 1 OAX intermediate toggle



GUG101TWMS

Product code	Description	Pack qty
GUG101T*SS	Stainless steel	1
GUG101T*MS	Mirror steel	1
GUG101TWPW	Painted white with white interior	1
GUG101TWPN	Pearl nickel with white interior	1
GUG101TBBN	Black nickel with black interior	1
GUG101T*PB	Polished brass	1

# Key switch grid modules

## 20AX 1 way key operated double-pole



GUG20DPKWMS

Product code	Description	Pack qty
GUG20DPK*SS	Stainless steel	1
GUG20DPK*MS	Mirror steel	1
GUG20DPKWPW	Painted white with white interior	1
GUG20DPKWPN	Pearl nickel with white interior	1
GUG20DPKBNN	Black nickel with black interior	1
GUG20DPK*PB	Polished brass	1

- **Standard of compliance:** BS EN 60669-1
- **Mounting box:** 42mm deep
- **Technical notes:** Mirror steel used for polished chrome grid plates & modules.

## 20AX 2 way key operated



GUG202KWMS

Product code	Description	Pack qty
GUG202K*SS	Stainless steel	1
GUG202K*MS	Mirror steel	1
GUG202KWPW	Painted white with white interior	1
GUG202KWPN	Pearl nickel with white interior	1
GUG202KBNN	Black nickel with black interior	1
GUG202K*PB	Polished brass	1

## 20AX 2 way key operated printed red TEST EMG LTG



GUG202KELWMS

Product code	Description	Pack qty
GUG202KEL*SS	Stainless steel	1
GUG202KEL*MS	Mirror steel	1
GUG202KELWPW	Painted white with white interior	1
GUG202KELWPN	Pearl nickel with white interior	1
GUG202KELBNN	Black nickel with black interior	1
GUG202KEL*PB	Polished brass	1

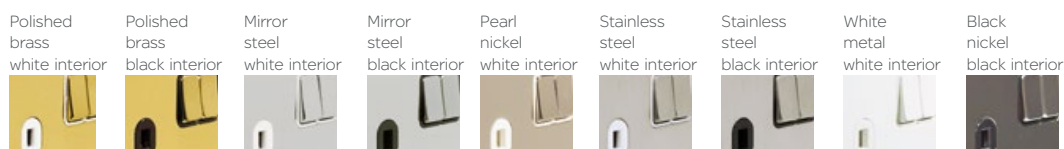

# Telephone grid modules

## BT master telephone



GUGTELMWMS

Product code	Description	Pack qty
GUGTELM*SS	Stainless steel	1
GUGTELM*MS	Mirror steel	1
GUGTELMWPW	Painted white with white interior	1
GUGTELMWPN	Pearl nickel with white interior	1
GUGTELMBBN	Black nickel with black interior	1
GUGTELM*PB	Polished brass	1

- **Standard of compliance:** BS EN 3041 (where applicable)
- **Mounting box:** 42mm deep
- **Technical notes:** Mirror steel used for polished chrome grid plates & modules.

## BT secondary telephone



GUGTELSWMS

Product code	Description	Pack qty
GUGTELS*SS	Stainless steel	1
GUGTELS*MS	Mirror steel	1
GUGTELSWPW	Painted white with white interior	1
GUGTELSWPN	Pearl nickel with white interior	1
GUGTELSBBN	Black nickel with black interior	1
GUGTELS*PB	Polished brass	1

## RJ11 telephone



GUGRJ11WMS

Product code	Description	Pack qty
GUGRJ11*SS	Stainless steel	1
GUGRJ11*MS	Mirror steel	1
GUGRJ11WPW	Painted white with white interior	1
GUGRJ11WPN	Pearl nickel with white interior	1
GUGRJ11BBN	Black nickel with black interior	1
GUGRJ11*PB	Polished brass	1

# Data & TV grid modules

## RJ45 CAT5e



GUGRJ45WMS

Product code	Description	Pack qty
GUGRJ45*SS	Stainless steel	1
GUGRJ45*MS	Mirror steel	1
GUGRJ45WPW	Painted white with white interior	1
GUGRJ45WPN	Pearl nickel with white interior	1
GUGRJ45BBN	Black nickel with black interior	1
GUGRJ45*PB	Polished brass	1

- **Standard of compliance:** BS EN 3041 (where applicable)
- **Mounting box:** 42mm deep
- **Technical notes:** Mirror steel used for polished chrome grid plates & modules.

## Direct coaxial TV



GUGCOWMS

Product code	Description	Pack qty
GUGCO*SS	Stainless steel	1
GUGCO*MS	Mirror steel	1
GUGCOWPW	Painted white with white interior	1
GUGCOWPN	Pearl nickel with white interior	1
GUGCOBBN	Black nickel with black interior	1
GUGCO*PB	Polished brass	1

## F type satellite



GUGSATWMS

Product code	Description	Pack qty
GUGSAT*SS	Stainless steel	1
GUGSAT*MS	Mirror steel	1
GUGSATWPW	Painted white with white interior	1
GUGSATWPN	Pearl nickel with white interior	1
GUGSATBBN	Black nickel with black interior	1
GUGSAT*PB	Polished brass	1

# Electronic dimmer grid modules

## 300W/VA universal multiway touch dimmer module



GUGEMWMS

Product code	Description	Pack qty
GUGEMDIM*SS16	Stainless steel	1
GUGEMDIM*MS16	Mirror steel	1
GUGEMDIMWPW16	Painted white with white interior	1
GUGEMDIMWPN16	Pearl nickel with white interior	1
GUGEMDIMBBN16	Black nickel with black interior	1
GUGEMDIM*PB16	Polished brass	1

- **Mounting box:** 42mm deep
- **Technical notes:** Min load 60W/50VA. Mirror steel used for polished chrome grid plates & modules.

## 300W/VA universal multiway touch dimmer module with infra red remote option (black or white)



GUGEMRDIMWMS16

Product code	Description	Pack qty
GUGEMRDIMW16	White	1
GUGEMRDIMB16	Black	1
GU6000RC1	1 channel IR remote control	1

- Electronic modules are capable of 2 way or multiway dimming.
- Retractive switch for use with electronic dimmers only.
- Not compatible with moulded grid plates.
- Modules will require derating when used in multi-gang applications.

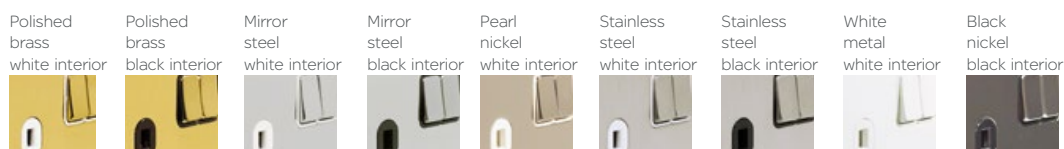



## Electronic dimmer grid modules continued

50mA 2 way & multiway retractive switch module



GUGEMRDIMW16

Product code	Description	Pack qty
GUGEMW*SS	Stainless steel	1
GUGEMW*MS	Mirror steel	1
GUGEMWWPW	Painted white with white interior	1
GUGEMWWPN	Pearl nickel with white interior	1
GUGEMWBBN	Black nickel with black interior	1
GUGEMW*PB	Polished brass	1

## Fuse carrier, flex outlet & blank grid modules

1 3A fuse carrier



GUG13FCUWMS

Product code	Description	Pack qty
GUG13FCU*SS	Stainless steel	1
GUG13FCU*MS	Mirror steel	1
GUG13FCUWPW	Painted white with white interior	1
GUG13FCUWPN	Pearl nickel with white interior	1
GUG13FCUBBN	Black nickel with black interior	1
GUG13FCU*PB	Polished brass	1

- **Standard of compliance:**  
BS 1363 (fuse carrier)  
BS 5733
- **Mounting box:**  
42mm deep
- **Technical notes:**  
Full metal surround on all modules  
Modules are completely interchangeable

Flex outlet up to 10mm ø



GUG16COWMS

Product code	Description	Pack qty
GUG16CO*SS	Stainless steel	1
GUG16CO*MS	Mirror steel	1
GUG16COWPW	Painted white with white interior	1
GUG16COWPN	Pearl nickel with white interior	1
GUG16COBBN	Black nickel with black interior	1
GUG16CO*PB	Polished brass	1

Mirror steel used for polished chrome grid plates & modules.

Blank



GUGBWMS

Product code	Description	Pack qty
GUGB*SS	Stainless steel	1
GUGB*MS	Mirror steel	1
GUGBWPW	Painted white with white interior	1
GUGBWPN	Pearl nickel with white interior	1
GUGBBBN	Black nickel with black interior	1
GUGB*PB	Polished brass	1
GUGB*	Moulded plastic (black or white)	1

# Indicator modules

## White surround



Product code	Description	Pack qty
GUGINDWG	Green indicator	1
GUGINDWR	Red indicator	1
GUGINDWO	Orange indicator	1

- **Standard of compliance:** BS 5733
- **Technical notes:** 240V

## Black surround



Product code	Description	Pack qty
GUGINDBG	Green indicator	1
GUGINDBR	Red indicator	1
GUGINDBO	Orange indicator	1

# Flush galvanised steel boxes

## 16mm deep



Product code	Description	Pack qty
SB161	1 gang	20

- **Standard of compliance:** BS4662
- **Technical notes:** Supplied with earth terminal and screw.

## 25mm deep



Product code	Description	Pack qty
SB251	1 gang	10
SB252	2 gang	10

Supplied with fixed and adjustable lugs.

Fitted with selection of 20mm knockouts in sides and back.

## 35mm deep



Product code	Description	Pack qty
SB351	1 gang	10
SB352	2 gang	5

# Flush galvanised steel boxes continued

47mm deep



SB472

Product code	Description	Pack qty
SB471	1 gang	10
SB472	2 gang	4

- **Standard of compliance:**  
BS4662

- **Technical notes:**  
Supplied with earth terminal and screw.

Supplied with fixed and adjustable lugs.

Fitted with selection of 20mm knockouts in sides and back.

# ULTIMATE Low Profile

An ideal upgrade solution for remodel and renovation projects, Ultimate Low Profile offers a contemporary and refreshing twist on traditional designs with its softly curved edge and quality metal finishes.

The forgiving 5mm plate depth provides generous wiring space and is useful when presented with uneven wall surfaces.

5mm Raised Edge offers easy installation access for new developments and remodel projects

Consistent profiles throughout the range allow accessories to be mounted adjacently

Colour-matched flat headed screws and eyelets add a finishes touch, while limiting the amount of tools needed for installation

Large plate footprint provides extra strength and reduces the need for additional decorating

Colour coded socket terminals and printed terminal numbering ensure that cable installation is simple and straight forward.

Long and Short Screws supplied with all low profile accessories for installation flexibility

Plated earth straps prevent corrosion, while inline angled terminals offer easy cable access during installation.

## Specification Highlights:



16AX switch rating across all plate switches offers a future-proofed lighting solution to accommodate increased load requirements & fluorescent lighting demands



50A rated plate switches for switching appliances with higher current ratings, such as heaters, cookers and commercial refrigerating units



Choose from a wide range of printed rocker caps to meet your customer requirements, with bespoke options available.

ULTIMATE  
LOW PROFILE



# Socket outlets

## 13A 1 gang single-pole switched



GU3510BBC

Product code	Description	Pack qty
GU3510*BC	Brushed chrome	1
GU3510*PC	Polished chrome	1

## 13A 2 gang single-pole switched



GU3520BBC

Product code	Description	Pack qty
GU3520*BC	Brushed chrome	1
GU3520*PC	Polished chrome	1

## 13A 2 gang double-pole switched with outboard rockers



GU3530BBC

Product code	Description	Pack qty
GU3530*BC	Brushed chrome	1
GU3530*PC	Polished chrome	1

## 5A unswitched round pin



GU3580BBC

Product code	Description	Pack qty
GU3530*BC	Brushed chrome	1
GU3530*PC	Polished chrome	1

- **Standard of compliance:**  
BS 1363 (13A)  
BS 546 (round pin)
- **Mounting box:**  
Minimum 25mm deep
- **Fixing screws:**  
M3.5 x 25mm and 30mm
- **Plate dimensions:**  
88 x 88mm (1 gang)  
88 x 148mm (2 gang)
- **Technical notes:**  
All 2 gang sockets supplied with twin earth terminals as standard.

# Plate switches

## 16AX 1 gang 2 way



GU1512BBC

Product code	Description	Pack qty
GU1512*BC	Brushed chrome	1
GU1512*PC	Polished chrome	1

## 16AX 1 gang intermediate



GU1514BBC

Product code	Description	Pack qty
GU1514*BC	Brushed chrome	1
GU1514*PC	Polished chrome	1

## 16AX 2 gang 2 way



GU1522BBC

Product code	Description	Pack qty
GU1522*BC	Brushed chrome	1
GU1522*PC	Polished chrome	1

- **Standard of compliance:**  
BS EN 60669-1
- **Mounting box:**  
16mm deep (1-2 gang)
- **Fixing screws:**  
M3.5 x 25mm and 30mm
- **Plate dimensions:**  
88 x 88mm (1-3 gang)

 Polished chrome  
white interior

 Polished chrome  
black interior

 Brushed chrome  
white interior

 Brushed chrome  
black interior

## Plate switches continued

### 16AX 3 gang 2 way



GU1532BBC

Product code	Description	Pack qty
GU1532*BC	Brushed chrome	1
GU1532*PC	Polished chrome	1

- **Standard of compliance:**  
BS EN 60669-1  
BS EN 60947-3  
(GU1513\*\*\*)
- **Mounting box:**  
25mm deep (3-4 gang)
- **Fixing screws:**  
M3.5 x 25mm and  
30mm
- **Plate dimensions:**  
88 x 88mm (1-3 gang),  
88 x 148mm (4 gang)

### 16AX 4 gang 2 way



GU1542BBC

Product code	Description	Pack qty
GU1542*BC	Brushed chrome	1
GU1542*PC	Polished chrome	1

### 10A triple pole isolator



GU1513BBC

Product code	Description	Pack qty
GU1513*BC	Brushed chrome	1
GU1513*PC	Polished chrome	1

## Dimmer switches

### 1 gang 2 way 400W/VA mains & low voltage



GU6512CBC

Product code	Description	Pack qty
GU6512CBC	Brushed chrome	1
GU6512CPC	Polished chrome	1

- **Standard of compliance:**  
BS EN 60669-2-1
- **Mounting box:**  
25mm deep (1-2 gang)  
35mm deep (3 gang)
- **Fixing screws:**  
M3.5 x 25mm and  
30mm
- **Plate dimensions:**  
88 x 88mm (1-2 gang)  
88 x 148mm (3 gang)
- **Technical notes:**  
All dimmers not suitable  
with CFL lighting.

### 2 gang 2 way 250W/VA mains & low voltage

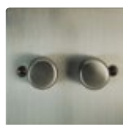

GU6522CBC

Product code	Description	Pack qty
GU6522CBC	Brushed chrome	1
GU6522CPC	Polished chrome	1

### 3 gang 2 way 250W/VA mains & low voltage



GU6532CBC

Product code	Description	Pack qty
GU6532CBC	Brushed chrome	1
GU6532CPC	Polished chrome	1

Mains & low voltage and  
electronic dimmers not  
suitable for use with LED  
lamps.

Mains & low voltage  
dimmers - leading edge  
control.

## Control switches

### 20AX double-pole 1 gang with neon



GU2511BBC

Product code	Description	Pack qty
GU2511*BC	Brushed chrome	1
GU2511*PC	Polished chrome	1

- **Standard of compliance:**  
BS EN 60669-1
- **Mounting box:**  
35mm deep
- **Fixing screws:**  
M3.5 x 25mm and 30mm
- **Plate dimensions:**  
88 x 88mm

### 20AX double-pole 1 gang with flex outlet



GU2513BBC

Product code	Description	Pack qty
GU2513*BC	Brushed chrome	1
GU2513*PC	Polished chrome	1

## Fused connection units

### 1 3A unswitched



GU5500BBC

Product code	Description	Pack qty
GU5500*BC	Brushed chrome	1
GU5500*PC	Polished chrome	1

- **Standard of compliance:**  
BS 1363
- **Mounting box:**  
25mm deep (unswitched)  
35mm deep (switched)
- **Fixing screws:**  
M3.5 x 25mm and 30mm
- **Plate dimensions:**  
88 x 88mm

### 1 3A double-pole switched



GU5510BBC

Product code	Description	Pack qty
GU5510*BC	Brushed chrome	1
GU5510*PC	Polished chrome	1

### 1 3A double-pole switched with neon



GU5511BBC

Product code	Description	Pack qty
GU5511*BC	Brushed chrome	1
GU5511*PC	Polished chrome	1

### 1 3A double-pole switched with neon & flex outlet



GU5514BBC

Product code	Description	Pack qty
GU5514*BC	Brushed chrome	1
GU5514*PC	Polished chrome	1



# High current switches

50A 2 gang double-pole switches with neon



GU4521BBC

Product code	Description	Pack qty
GU4521*BC	Brushed chrome	1
GU4521*PC	Polished chrome	1

45A double-pole cooker control unit with 1 3A switched socket & neons



GU4501BBC

Product code	Description	Pack qty
GU4501*BC	Brushed chrome	1
GU4501*PC	Polished chrome	1

- **Standard of compliance:**  
BS EN 60669-1 (switches)  
BS 4177 (cooker control units)
- **Mounting box:**  
47mm deep
- **Fixing screws:**  
M3.5 x 25mm and 30mm
- **Plate dimensions:**  
148 x 88mm (switches),  
88 x 148mm (cooker control units)

# Shaver socket

115/230V dual voltage



GU7590BBC

Product code	Description	Pack qty
GU7590*BC	Brushed chrome	1
GU7590*PC	Polished chrome	1

- **Standard of compliance:**  
BS EN 61558-2-5
- **Mounting box:**  
47mm deep
- **Fixing screws:**  
M3.5 x 25mm and 30mm
- **Plate dimensions:**  
148 x 88mm
- **Technical notes:**  
Unique design allows perfect fit to 47mm box.

# Telephone outlets

Master BT telephone



GU7561BBC

Product code	Description	Pack qty
GU7561*BC	Brushed chrome	1
GU7561*PC	Polished chrome	1

Secondary BT telephone



GU7562BBC

Product code	Description	Pack qty
GU7562*BC	Brushed chrome	1
GU7562*PC	Polished chrome	1

- **Standard of compliance:**  
BS EN 41003
- **Mounting box:**  
Minimum 25mm deep
- **Fixing screws:**  
M3.5 x 25mm and 30mm
- **Plate dimensions:**  
88 x 88mm
- **Technical notes:**  
Refer to euro plate & modules section for combined telephone & data solutions.

Polished chrome  
white interior



Polished chrome  
black interior



Brushed chrome  
white interior



Brushed chrome  
black interior



# TV outlets

Single TV/FM



GU7510BBC

Product code	Description	Pack qty
GU7510*BC	Brushed chrome	1
GU7510*PC	Polished chrome	1

- **Standard of compliance:** BS 3041 (where applicable)
- **Mounting box:** 25mm deep
- **Fixing screws:** M3.5 x 25mm and 30mm
- **Plate dimensions:** 88 x 88mm
- **Technical notes:** Products are direct connection and not suitable for common connection

# Euro modular plates & modules

1 gang euro plate, 1 module 25 x 50mm



GU8550PC

Product code	Description	Pack qty
GU8550BC	Brushed chrome	1
GU8550PC	Polished chrome	1

- **Mounting box:** Refer to module for appropriate mounting box depth
- **Plate dimensions:** 88 x 88mm (1 gang)  
88 x 148mm (2 gang)
- **Technical notes:** Mounting grid supplied with euro plate.

1 gang euro plate, 2 module 50 x 50mm



GU8560PC

Product code	Description	Pack qty
GU8560BC	Brushed chrome	1
GU8560PC	Polished chrome	1

2 gang euro plate, 4 module 100 x 50mm



GU8580BC

Product code	Description	Pack qty
GU8580BC	Brushed chrome	1
GU8580PC	Polished chrome	1

Polished chrome  
white interior



Polished chrome  
black interior



Brushed chrome  
white interior



Brushed chrome  
black interior



# Euro modular plates & modules continued

## 25 x 50mm euro modules



Product code	Description	Pack qty
GUE7011*	Single IEC coax (female)	1
GUE7012*	25 x 50mm euro modules IEC coax (male)	1
GUE7030*	Single F type sat	1
GUE7061*	BT master telephone	1
GUE7062*	BT secondary telephone	1
GUE7071*	RJ45 CAT5e (not screened)	1
GUE7072*	RJ45 CAT6 (not screened)	1
GUE7073*	Single USB charger 1A 5Vdc	1
GUE7051*	RJ11 modem	1
GUE7075*	VGA	1
GUE7091*	LexCom Performance outlet	8
GUE7000*	2 x Phono socket	1
GUE7001*	25 x 50mm euro 2 x Loudspeaker socket	1
GUE8010*	25 x 50mm euro Blank module	5

## 50 x 50mm euro modules



Product code	Description	Pack qty
GUE7010*	TV/FM diplexer	1
GUE7040*	TV/Sat diplexer	1
GUE7074*	Twin USB charger 2 x 1A 5Vdc	1
GUE7081*	TV/FM/Sat triplexer	1
GUE7082*	TV/FM/Sat1/Sat2 quadplexer	1
GUE7020*	HDMI	1

# Blank plates & accessories

## 1 gang



GU8510BC

Product code	Description	Pack qty
GU8510BC	Brushed chrome	1
GU8510PC	Polished chrome	1

- **Standard of compliance:** BS 5733
- **Fixing screws:** M3.5 x 25mm and 30mm
- **Plate dimensions:** 88 x 88mm (1 gang), 88 x 148mm (2 gang)

## 2 gang



GU8520BC

Product code	Description	Pack qty
GU8520BC	Brushed chrome	1
GU8520PC	Polished chrome	1
3746130	M3.5 x 25mm raised head machine screws	100
USCREW50SS	M3.5 x 50mm screws	100

# Grid plates

## 1 gang 88 x 88mm



GUGL01BC

Product code	Description	Pack qty
GUGL01BC	Brushed chrome	1
GUGL01MS	Polished chrome	1
GBG01	76 x 76 x 42mm back box	1

- **Mounting box:**  
42mm deep
- **Technical notes:**  
All grid plates are supplied with the appropriate number of mounting frames.

## 2 gang 88 x 88mm



GUGL02BC

Product code	Description	Pack qty
GUGL02BC	Brushed chrome	1
GUGL02MS	Polished chrome	1
GBG01	76 x 76 x 42mm back box	1

## 3 gang 88 x 148mm



GUGL03BC

Product code	Description	Pack qty
GUGL03BC	Brushed chrome	1
GUGL03MS	Polished chrome	1
GBG02	136 x 76 x 42mm back box	1

## 4 gang 88 x 148mm



GUGL04BC

Product code	Description	Pack qty
GUGL04BC	Brushed chrome	1
GUGL04MS	Polished chrome	1
GBG02	136 x 76 x 42mm back box	1

## 6 gang 156 x 156mm



GUGL06BC

Product code	Description	Pack qty
GUGL06BC	Brushed chrome	1
GUGL06MS	Polished chrome	1
GBG03	136 x 136 x 42mm back box	1

## 8 gang 156 x 156mm



GUGL08BC

Product code	Description	Pack qty
GUGL08BC	Brushed chrome	1
GUGL08MS	Polished chrome	1
GBG03	136 x 136 x 42mm back box	1

Polished chrome  
white interior



Polished chrome  
black interior



Brushed chrome  
white interior



Brushed chrome  
black interior



# Customisable switch grid modules

10AX metal switch module components (white or black surrounds)



GUG102MB GUG101MW

Product code	Description	Pack qty
GUG101M*	10AX 1 way SP	1
GUG102M*	10AX 2 way SP	1
GUG101M*	10AX intermediate SP	1

- **Standard of compliance:** BS EN 60669-1
- **Mounting box:** 42mm deep
- **Technical notes:** 10AX & 20AX metal switch module components available in black or white.
- Clear terminal marking printed onto grey switch module component back mouldings ensures easy identification.
- Pre-printed rocker caps
- Easy assembly

20AX metal switch module components (white or black surrounds)



GUG2020MB GUG20DPMW

Product code	Description	Pack qty
GUG201M*	20AX 1 way SP	1
GUG2020M*	20AX 2 way and off SP	1
GUG202M*	20AX 2 way SP	1
GUG20DPM*	20AX DP	1

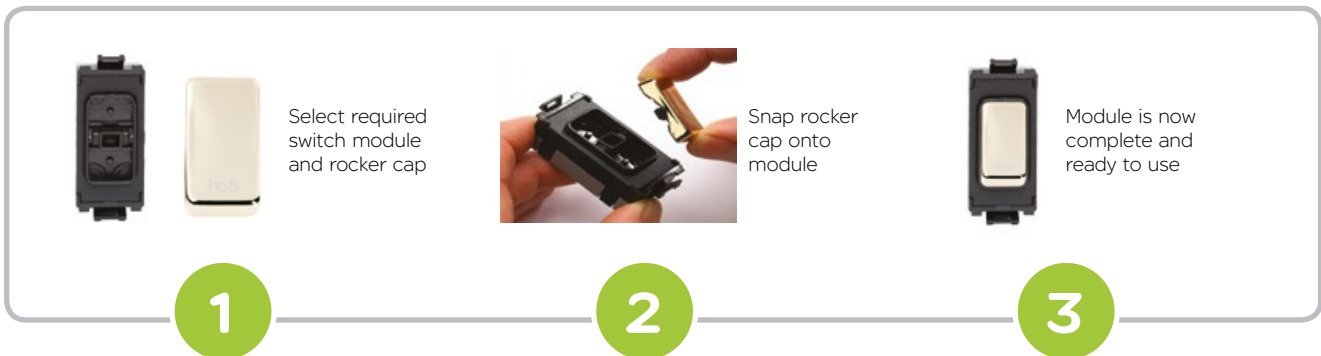

## Plain and printed rocker caps for component modules



GUGRBOMS



GUGRHOPW



GUGRBOBLK

	Mirror Steel	Painted White	Painted Black	Pack qty
Plain rocker cap	GUGRMS	GUGRPW	GUGRBLK	6
Rocker cap printed boiler	GUGRBOMS	GUGRBOPW	GUGRBOBLK	6
Rocker cap printed cooker hood	GUGRCHMS	GUGRCHPW	GUGRCHBLK	6
Rocker cap printed dish washer	GUGRDWMS	GUGRDWPW	GUGRDWBLK	6
Rocker cap printed extractor fan	GUGREFMS	GUGREFPW	GUGREFBLK	6
Rocker cap printed fridge	GUGRFRMS	GUGRFRPW	GUGRFRBLK	6
Rocker cap printed fan	GUGRFAMS	GUGRFAPW	GUGRFABLK	6
Rocker cap printed freezer	GUGRFZMS	GUGRFZPW	GUGRFZBLK	6
Rocker cap printed fridge/freezer	GUGRFRFZMS	GUGRFRFZPW	GUGRFRFZBLK	6
Rocker cap printed hob	GUGRHOMS	GUGRHOPW	GUGRHOBK	6
Rocker cap printed heater	GUGRHEMS	GUGRHEPW	GUGRHEBLK	6
Rocker cap printed microwave	GUGRMWMS	GUGRMWPW	GUGRMWBLK	6
Rocker cap printed oven	GUGROVMS	GUGROVPW	GUGROVBLK	6
Rocker cap printed tumble dryer	GUGRTDMS	GUGRTDPW	GUGRTDBLK	6
Rocker cap printed washer dryer	GUGRWDYMS	GUGRWDYPW	GUGRWDYBLK	6
Rocker cap printed waste disposal	GUGRDWMS	GUGRDWPW	GUGRDWBLK	6
Rocker cap printed washing machine	GUGRWMS	GUGRWMPW	GUGRWMBLK	6

## Retractive & toggle switch grid modules

### 6AX 2 way retractive and centre off



GUG202OCBLK

Product code	Description	Pack qty
GUG202OC*MS	Mirror Steel	1
GUG202OCBLK	Painted black with black interior	1
GUG202OCWPW	Painted white with white interior	1

- **Standard of compliance:** BS EN 60669-1
- **Mounting box:** 42mm deep
- **Technical notes:** Mirror steel used for polished chrome grid modules.

### 6AX 2 way and centre off



GUG2020BLK

Product code	Description	Pack qty
GUG2020*MS	Mirror Steel	1
GUG2020BLK	Painted black with black interior	1
GUG2020WPW	Painted white with white interior	1

### 10AX 2 way retractive single-pole



GUG102RBLK

Product code	Description	Pack qty
GUG102R*MS	Mirror Steel	1
GUG102RBLK	Painted black with black interior	1
GUG102RWPW	Painted white with white interior	1

# Retractive & toggle switch grid modules continued

## 10AX 2 way single-pole toggle



GUG102TWPW

Product code	Description	Pack qty
GUG102T*MS	Mirror Steel	1
GUG102TWPW	Painted white with white interior	1

## 10AX intermediate toggle



GUG102TWPW

Product code	Description	Pack qty
GUG101T*MS	Mirror Steel	1
GUG101TWPW	Painted white with white interior	1

# Key switch grid modules

## 20AX 1 way double-pole key operated



GUG20DPKBLK

Product code	Description	Pack qty
GUG20DPK*MS	Mirror Steel	1
GUG20DPKBLK	Painted black with black interior	1
GUG20DPKWPW	Painted white with white interior	1

- **Standard of compliance:**  
BS EN 60669-1
- **Mounting box:**  
42mm deep
- **Technical notes:**  
Mirror steel used for polished chrome grid modules.

## 20AX 2 way key operated



GUG202KBLK

Product code	Description	Pack qty
GUG202K*MS	Mirror Steel	1
GUG202KBLK	Painted black with black interior	1
GUG202KWPW	Painted white with white interior	1

## 20AX 2 way key operated printed red TEST EMG LTG



GUG202KELBLK

Product code	Description	Pack qty
GUG202KEL*MS	Mirror Steel	1
GUG202KELBLK	Painted black with black interior	1
GUG202KELWPW	Painted white with white interior	1

## Telephone grid modules

### BT master telephone



GUGTEMLBLK

Product code	Description	Pack qty
GUGTELM*MS	Mirror Steel	1
GUGTEMLBLK	Painted black with black interior	1
GUGTELMWPW	Painted white with white interior	1

- **Standard of compliance:**  
BS EN 3041  
(where applicable)
- **Mounting box:**  
42mm deep
- **Technical notes:**  
Mirror steel used for polished chrome grid modules.

### BT secondary telephone



GUGTELSBLK

Product code	Description	Pack qty
GUGTELS*MS	Mirror Steel	1
GUGTELSBLK	Painted black with black interior	1
GUGTELSWPW	Painted white with white interior	1

### RJ11 telephone



GUGRJ11BLK

Product code	Description	Pack qty
GUGRJ11*MS	Mirror Steel	1
GUGRJ11BLK	Painted black with black interior	1
GUGRJ11WPW	Painted white with white interior	1

## Data & TV grid modules

### RJ45 CAT5e



GUGRJ45BLK

Product code	Description	Pack qty
GUGRJ45*MS	Mirror Steel	1
GUGRJ45BLK	Painted black with black interior	1
GUGRJ45WPW	Painted white with white interior	1

- **Standard of compliance:**  
BS EN 3041  
(where applicable)
- **Mounting box:**  
42mm deep
- **Technical notes:**  
Mirror steel used for polished chrome grid modules.

### Direct coaxial TV



GUGCOBLK

Product code	Description	Pack qty
GUGCO*MS	Mirror Steel	1
GUGCOBLK	Painted black with black interior	1
GUGCOWPW	Painted white with white interior	1

### F type satellite



GUGSATBLK

Product code	Description	Pack qty
GUGSAT*MS	Mirror Steel	1
GUGSATBLK	Painted black with black interior	1
GUGSATWPW	Painted white with white interior	1

Polished chrome  
white interiorPolished chrome  
black interiorBrushed chrome  
white interiorBrushed chrome  
black interior



## Electronic dimmer grid modules

### 300W/VA universal multiway touch dimmer module



GUGEMDIMWPW16

Product code	Description	Pack qty
GUGEMDIM*MS16	Mirror Steel	1
GUGEMDIMBLK16	Painted black with black interior	1
GUGEMDIMWPW16	Painted white with white interior	1

- **Mounting box:** 42mm deep
- **Technical notes:** Min load 60W/50VA.

Mirror steel used for polished chrome grid modules.

### 300W/VA universal multiway touch dimmer module with infra red remote option



GUGEMRDIMB16

Product code	Description	Pack qty
GUGEMRDIMB16	Black moulded	1
GUGEMRDIMW16	White moulded	1
GU6000RC1	1 channel IR remote control	1

- Electronic modules are capable of 2 way or multiway dimming.
- Retractive switch for use with electronic dimmers only.
- Not compatible with moulded grid plates.
- Modules will require derating when used in multi-gang applications.

### 50mA 2 way & multiway retractive switch module



GUGEMWWPW

Product code	Description	Pack qty
GUGSAT*MS	Mirror Steel	1
GUGSATBLK	Painted black with black interior	1
GUGSATWPW	Painted white with white interior	1

## Fuse carrier, flex outlet & blank grid modules

### 1 3A fuse carrier



GUG13FCUBLK

Product code	Description	Pack qty
GUG13FCU*MS	Mirror Steel	1
GUG13FCUBLK	Painted black with black interior	1
GUG13FCUWPW	Painted white with white interior	1

- **Standard of compliance:** BS 1363 (fuse carrier) BS 5733
- **Mounting box:** 42mm deep
- **Technical notes:** Full metal surround on all modules

Modules are completely interchangeable

Mirror steel used for polished chrome grid modules.

### Flex outlet up to 10mm ø



GUG16COBLK

Product code	Description	Pack qty
GUG16CO*MS	Mirror Steel	1
GUG16COBLK	Painted black with black interior	1
GUG16COWPW	Painted white with white interior	1

### Blank



GUGBB

Product code	Description	Pack qty
GUGB*MS	Mirror Steel	1
GUGBBLK	Painted black with black interior	1
GUGBWPW	Painted white with white interior	1

# Indicator modules

## White surround



GUGINDWG GUGINDWR



GUGINDWO

Product code	Description	Pack qty
GUGINDWG	Green indicator	1
GUGINDWR	Red indicator	1
GUGINDWO	Orange indicator	1

- **Standard of compliance:** BS 5733
- **Mounting box:** 42mm deep
- **Technical notes:** 240V

## Black surround



GUGINDBG GUGINDBR



GUGINDBO

Product code	Description	Pack qty
GUGINDBG	Green indicator	1
GUGINDBR	Red indicator	1
GUGINDBO	Orange indicator	1

- **Standard of compliance:** BS 5733
- **Mounting box:** 42mm deep
- **Technical notes:** 240V

# Flush galvanised steel boxes

## 16mm deep



SB161

Product code	Description	Pack qty
SB161	1 gang	20

- **Technical notes:**  
Supplied with earth terminal and screw.

Supplied with fixed and adjustable lugs.

Fitted with selection of 20mm knockouts in sides and back.

## 25mm deep

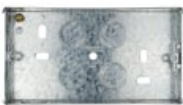

SB252

Product code	Description	Pack qty
SB251	1 gang	10
SB252	2 gang	10

## 35mm deep



SB351

Product code	Description	Pack qty
SB351	1 gang	10
SB352	2 gang	5

## 47mm deep



SB472

Product code	Description	Pack qty
SB471	1 gang	10
SB472	2 gang	4

LISSE



# Curves in all the right places...

The Lisse white moulded range of wiring accessories offers the perfect blend of style and performance.

You no longer have to choose between convenience and efficiency, or compromise on appearance to get the most innovative features. Lisse is packed with a vast array of technical features, providing a high level of quality, reliability and value you can count on.



- Ideally suited for new construction and refurbishment projects
- Future-proofed to cater for the latest demands in consumer technology
- Made from durable, high quality urea with antimicrobial properties
- Cleverly designed to ensure that product ordering is simple and efficient, with many time and space saving solutions.
- Crafted with your customer in mind, adding bespoke solutions to make a lasting impact

# Quality as standard...

The smooth, modern lines of Lisse offer an understated elegance to compliment today's interiors.

Not only that - every attention to detail has been paid to the design and construction of this elegant white moulded range, built to make your installation faster, smoother, simpler...

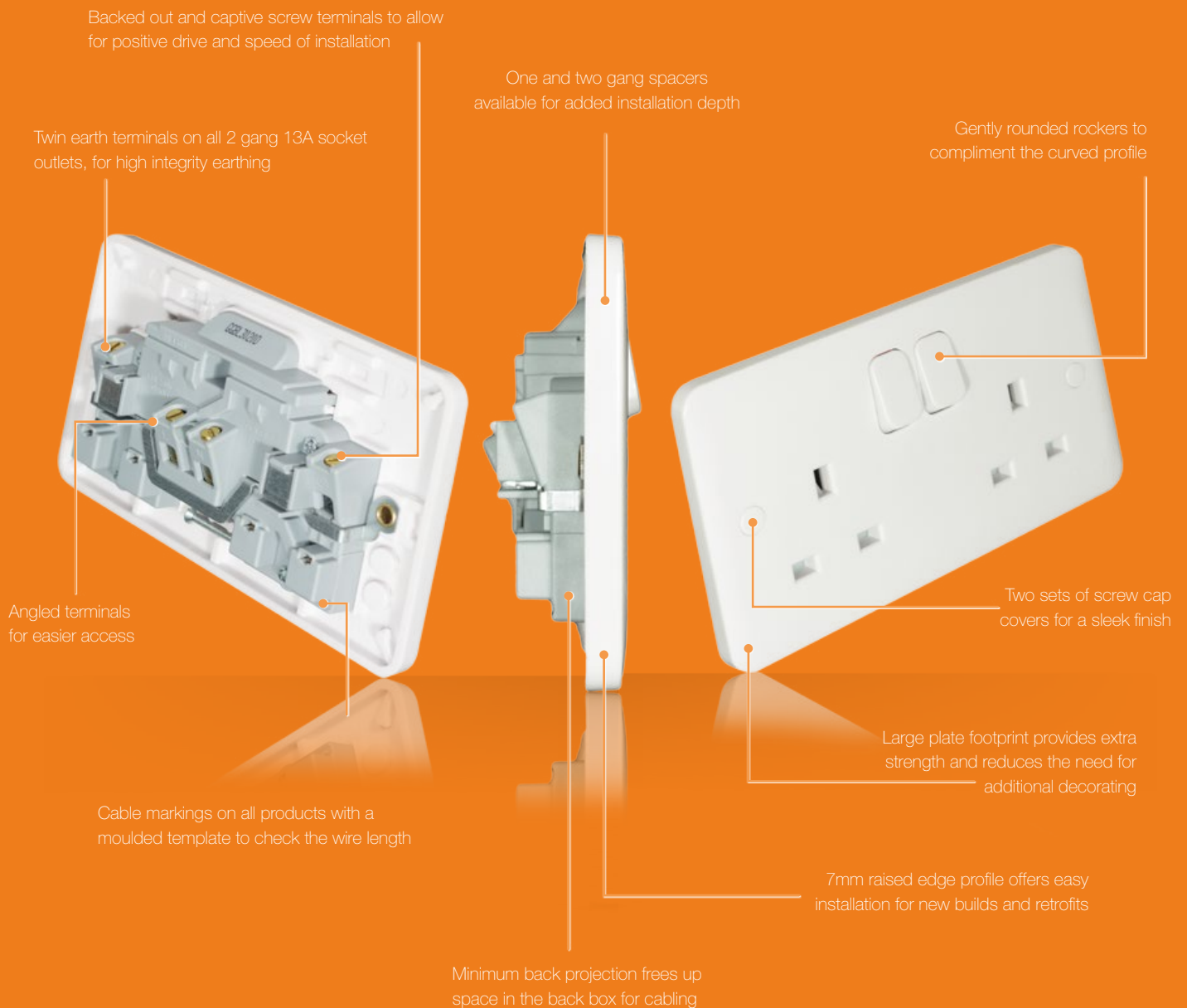

# Tailored to meet your needs...



Lisse has been cleverly designed to ensure that product ordering is simple and efficient, with many time and space saving solutions. What does this mean for you? Faster ordering, fewer part references and greater installation flexibility.



## Clever Illumination

Enjoy the subtle but elegant illumination provided by Lisse LED indicators. This optional feature shines through the front plate moulding when additional power indication is needed. Installation couldn't be easier, as the LED indicators are simply clipped in to place via a purpose-built holding space on the back of the front plate and leverage dedicated push terminals for cabling.



## Flexible Frames

Optional Flex outlet frames offer the additional cabling depth you need on site, without having to hold stock variations of the same product. Simply clip in to place with your standard FCU or control switch to install. One and two gang spacers are also available to provide the perfect solution for remodels and retrofits when extra installation depth is needed.

## Fully Antimicrobial

Lisse wiring devices can be used seamlessly with the Ultimate or Cableline anti-microbial 3 compartment trunking systems, to provide a high level of resistance to MRSA, E-Coli, Salmonella and Klebsiella Penumoniae.

# For every application

With such a comprehensive product range, Lisse white moulded allows you to find everything that you need to meet the demands of today's modern installations.

## Flexible Grid Solutions

Available in 1 to 8 gang with accompanying modules. Installation is made easy with its slot headed screw design, and ordering is simplified as mounting frames are supplied with each grid front plate.



## Added Safety & Security

The Lisse lockable socket or switch is ideal for communal areas in order to prevent injury risks and unauthorised energy usage.



## Stay connected

Help customers stay connected to their TVs, game consoles, computers, and sound systems with Lisse. Choose from a full range of multimedia connectors, USB charging solutions, and combination plates.

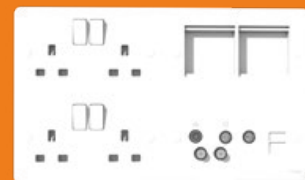

## Dimming Genius

Enjoy a comprehensive selection of dimming solutions with Lisse white moulded, from mains & low voltage compatibility through to LED, as well as the addition of 1-10V 6A control.



## Easy Conversions

The Lisse converta socket is an ideal retrofit solution when mounting box space is limited. Allows single to double socket conversion without the need for additional cabling or chasing.







# Socket outlets

## 1 3A unswitched



GGBL3050



GGBL3060

Product code	Description	Pack qty
GGBL3050	1 gang	10
GGBL3050S	1 gang - display packaged	10
GGBL3060	2 gang	5
GGBL3060S	2 gang - display packaged	5

- **Standard of compliance:**  
BS 1363 (13A)
- **Mounting box:**  
Minimum 25mm deep
- **Fixing screws:**  
M3.5 x 25mm
- **Plate dimensions:**  
87 x 87mm (1 gang)  
87 x 148.5mm (2 gang)
- **Technical notes:**  
 Product compatible with LED indicator GGBLSIND.

## 1 3A 1 gang switched









GGBL3010



GGBL3050NS



GGBLTOP13ANS



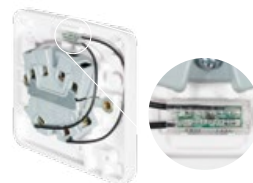

Product code	Description	Pack qty
GGBL3010	Single-pole 	10
GGBL3010S	Single-pole - display packaged 	10
GGBL3010D	Double-pole 	10
GGBL3010DS	Double-pole - display packaged 	10
GGBL3050NS	Single-pole non-standard - display packaged 	10
GGBLTOP13ANS	Non-standard plug top - display packaged 	20



## 1 3A 2 gang switched with inboard rockers



GGBL3020D

Product code	Description	Pack qty
GGBL3020	Single-pole 	5
GGBL3020S	Single-pole - display packaged 	5
GGBL3020DS	Double-pole - display packaged 	5
GGBL3020D	Double-pole 	5

## 1 3A 2 gang with outboard rockers



GGBL3030



GGBL30212DS

Product code	Description	Pack qty
GGBL3030	Double-pole 	5
GGBL3030S	Double-pole - display packaged 	5
GGBL30212DS	1 to 2 gang converta - display packaged 	5

## Lockable



GGBL3060L

Product code	Description	Pack qty
GGBL3060L	1 gang double-pole	5

## Round pin



GGBL3070 GGBL3080



GGBL3090

Product code	Description	Pack qty
GGBL3070	2A unswitched	10
GGBL3080	5A unswitched	10
GGBL3081	5A switched	10
GGBL3090	15A switched	10
GGBL3090S	15A switched - display packaged	10

- **Standard of compliance:**  
BS 546 (round pin)  
BS 5733  
BS EN 60950
- **Mounting box:**  
Minimum 25mm deep
- **Fixing screws:**  
M3.5 x 25mm
- **Plate dimensions:**  
87 x 87mm (1 gang)
- **Technical notes:**  
\*\* Product available from September 2015.

Product compatible with LED indicator GGBLSIND.

\* Not for UK use

## Schuko



GGBL3016A1

Product code	Description	Pack qty
GGBL3016A1	16A 1 gang unswitched*	10

## USB



GGBL30201USBS

Product code	Description	Pack qty
GGBL30201USBS	2 gang DP switched socket outlet with 1 x USB charger**	5
TBC	2 gang SP switched socket outlet with 2 x USB chargers**	5

# Plate switches

## 10AX 1 gang



GGBL1012

Product code	Description	Pack qty
GGBL1011	1 way	10
GGBL1011S	1 way - display packaged	10
GGBL1012	2 way	10
GGBL1012S	2 way - display packaged	10
GGBL1014	Intermediate	10
GGBL1014S	Intermediate - display packaged	10

- **Standard of compliance:**  
BS EN 60669-1
- **Mounting box:**  
16mm deep (1-2 gang)  
25mm deep (3 gang)
- **Fixing screws:**  
M3.5 x 18mm
- **Plate dimensions:**  
87 x 87mm (1-3 gang)

## 10A 1 gang retractive



GGBL1012RP GGBL1012RB

Product code	Description	Pack qty
GGBL1012R	1 gang	10
GGBL1012RS	1 gang - display packaged	10
GGBL1012RP	1 gang printed with press	10
GGBL1012RPS	1 gang printed with press - display packaged	10
GGBL1012RB	1 gang printed with bell symbol	10
GGBL1012RBS	1 gang printed with bell symbol - display packaged	10

## 10AX 2 & 3 gang



GGBL1022 GGBL1032

Product code	Description	Pack qty
GGBL1022	2 gang 2 way	10
GGBL1022S	2 gang 2 way - display packaged	10
GGBL1032	3 gang 2 way	10
GGBL1032S	3 gang 2 way - display packaged	10

# Plate switches continued

## 10AX 4 gang



GGBL1042

Product code	Description	Pack qty
GGBL1042	4 gang 2 way	5
GGBL1042S	4 gang 2 way - display packaged	5

## 10A triple pole isolators & 10AX



GGGBL1013

GGGBL1013S



GGBL10131R

Product code	Description	Pack qty
GGGBL1013	Triple pole isolator	10
GGGBL1013S	Triple pole isolator - display packaged	10
GGBL10131L	Isolator & 10AX 1 gang 2 way switch	5
GGBL10131R	1 gang 2 way switch & 10A isolator	5

- **Standard of compliance:**

BS EN 60669-1  
BS EN 60947-3  
(GGBL1013,  
GGBL10131L,  
GGBL10131R)

- **Mounting box:**

16mm deep (1-2 gang)  
25mm deep (3-6 gang)

- **Fixing screws:**

M3.5 x 18mm

- **Plate dimensions:**

87 x 148.5mm (4 gang)  
87 x 87mm (wide rockers)  
33 x 87mm  
(1 gang architrave)  
33 x 148.5mm  
(2 gang architrave)

## 10AX 1 gang wide rocker

GGBL1012W  
& GGGBL1014

Product code	Description	Pack qty
GGBL1012W	2 way	10
GGBL1012WS	2 way - display packaged	10
GGGBL1014W	Intermediate	10
GGGBL1014WS	Intermediate - display packaged	10

## 10AX 2 & 3 gang wide rocker



GGBL1022W

GGGBL1032W

Product code	Description	Pack qty
GGBL1022W	2 gang 2 way	10
GGBL1022WS	2 gang 2 way - display packaged	10
GGGBL1032W	3 gang 2 way	10
GGGBL1032WS	3 gang 2 way - display packaged	10

## 10AX architrave



GGBL1012ARP

Product code	Description	Pack qty
GGBL1012A	1 gang 2 way	10
GGBL1012AS	1 gang 2 way - display packaged	10
GGBL1012116AS	1 gang 2 way & 16mm pattress - display packaged	10
GGBL1012ARP	1 gang 2 way retractive printed press	10
GGBL1022A	2 gang 2 way	10

# Dimmer switches

## Mains & low voltage



GGBL6012CS

Product code	Description	Pack qty
GGBL6011CS	250W 1 gang 1 way mains - display packaged	5
GGBL6012CS	400W/VA 1 gang 2 way - display packaged	5
GGBL6022CS	250W/VA 2 gang 2 way - display packaged	5
GGBL6032CS	250W/VA 3 gang 2 way - display packaged	5
GGBL6042CS	250W/VA 4 gang 2 way mains & low voltage - display packaged	5

## 1-10V 6A



GGBL6022V4S

Product code	Description	Pack qty
GGBL6012V4S	1 gang 2 way - display packaged §	5
GGBL6022V4S	2 gang 2 way - display packaged §	5
GGBL6032V4S	3 gang 2 way - display packaged §	5
GGBL6042V4S	4 gang 2 way - display packaged §	5

## LED



GGBL6012LS GGBL6022LS

Product code	Description	Pack qty
GGBL6012LS	100W/VA 1 gang 2 way - display packaged	5
GGBL6022LS	100W/VA 2 gang 2 way - display packaged	5

- **Standard of compliance:**  
BS EN 60669-2-1
- **Mounting box:**  
16mm deep (GGBL6011CS)  
25mm deep
- **Fixing screws:**  
M3.5 x 18mm (GGBL6011CS)  
M3.5 x 25mm
- **Plate dimensions:**  
87 x 87mm (1-2 gang)  
87 x 148.5mm (3-4 gang)

- **Technical notes:**  
§ products not available until October 2015.

Mains & low voltage dimmers: leading edge control

LED dimmers: trailing edge control

# Control switches & flex outlet plates

## 20AX DP 1 gang switched



GGBL2010



GGBL2010LS

Product code	Description	Pack qty
GGBL2010	1 gang	10
GGBL2010LS	Lockable - display packaged	5



- **Standard of compliance:**  
BS EN 60669-1 (switches)
- **Mounting box:**  
25mm deep
- **Fixing screws:**  
M3.5 x 25mm
- **Plate dimensions:**  
87 x 87mm (1 gang)
- **Technical notes:**  
 Product compatible with LED indicator GGBLSIND.

Custom engraving available upon request.

# Control switches & flex outlet plates continued

## 20AX DP 1 gang switched with LED indicator



GGBL2011

Product code	Description	Pack qty
GGBL2011	1 gang	10
GGBL2011S	1 gang - display packaged	10
GGBL2014WH	1 gang with flex outlet frame engraved water heater	10

- **Standard of compliance:**  
BS EN 60669-1 (switches)  
BS 5733 (flex outlet plates)
- **Mounting box:**  
25mm deep
- **Fixing screws:**  
M3.5 x 25mm
- **Plate dimensions:**  
87 x 87mm

## 32A DP 1 gang switched



GGBL4031

Product code	Description	Pack qty
GGBL4031	DP 1 gang with LED indicator	10



## Flex outlet plates

GGBL2033,  
GGBL2033S

Product code	Description	Pack qty
GGBL2033	25A side entry	10
GGBL2033S	25A side entry - display packaged	10

- Custom engravings available upon request.

# Fused connection units

## 1 3A unswitched



GGBL5000

Product code	Description	Pack qty
GGBL5000	13A unswitched	10
GGBL5000S	13A unswitched - display packaged	10

- **Standard of compliance:**  
BS 1363
- **Mounting box:**  
25mm deep
- **Fixing screws:**  
M3.5 x 25mm
- **Plate dimensions:**  
87 x 87mm
- **Technical notes:**  
 Product compatible with LED indicator GGBLSIND.
- Custom engravings available upon request.

## 1 3A DP switched



GGBL5010

Product code	Description	Pack qty
GGBL5010	13A DP switched	10
GGBL5011	13A DP switched with LED indicator	10
GGBL5013S	13A DP switched with flex outlet frame - display packaged	10



# High current switches

## 50A DP switches with LED indicator



GGBL4011



GGBL4021

Product code	Description	Pack qty
GGBL4011	1 gang	5
GGBL4011S	1 gang - display packaged	10
GGBL4021	2 gang	5
GGBL4021S	2 gang - display packaged	5

- **Standard of compliance:**  
BS EN 60669-1 (switches)  
BS 4177 (cooker control units)
- **Mounting box:**  
40mm deep
- **Fixing screws:**  
M3.5 x 30mm
- **Plate dimensions:**  
87 x 87mm (1 gang)  
148.5 x 87mm (2 gang)

## 45A cooker control unit with 1 3A switched socket



GGBL4001

Product code	Description	Pack qty
GGBL4001	45A cooker control unit with LED indicators	1
GGBL4001S	45A cooker control unit with LED indicators - display packaged	5

## 50A cooker connection unit



GGBL4050

Product code	Description	Pack qty
GGBL4050	50A cooker connection unit	10
GGBL4050S	50A cooker connection unit - display packaged	10

# Shaver socket

## 115/230V dual voltage



GGBL7090S

Product code	Description	Pack qty
GGBL7090S	115/230V dual voltage - display packaged	1

- **Standard of compliance:**  
BS EN 61558-2-5
- **Mounting box:**  
40mm deep
- **Fixing screws:**  
M3.5 x 30mm
- **Plate dimensions:**  
148.5 x 87mm

# Telephone & data outlets

## USB charger outlets



GGBL70042

Product code	Description	Pack qty
GGBL70042	1 gang 2 x USB chargers **	10
GGBL70042S	1 gang 2 x USB chargers - display packaged **	10

- **Standard of compliance:**  
BS EN 41003
- **Mounting box:**  
25mm deep
- **Fixing screws:**  
M3.5 x 18mm
- **Plate dimensions:**  
87 x 87mm
- **Technical notes:**  
\*\* Product available from September 2015.  
§ Product available from May 2015.

## Telephone



GGBL7051

GGBL7061,  
GGBL7062

Product code	Description	Pack qty
GGBL7051	RJ12	10
GGBL7051S	RJ12 - display packaged	10
GGBL7061	BT master	10
GGBL7061S	BT master - display packaged	10
GGBL7062	BT secondary	10
GGBL7062S	BT secondary - display packaged	10

## RJ45 CAT5e UTP



GGBL7072C5

Product code	Description	Pack qty
GGBL7071C5	RJ45 CAT5e UTP single	10
GGBL7071C5S	RJ45 CAT5e UTP single - display packaged	10
GGBL7072C5	RJ45 CAT5e UTP twin	10
GGBL7072C5S	RJ45 CAT5e UTP twin - display packaged	10

## RJ45 CAT6 UTP



GGBL7071C6

Product code	Description	Pack qty
GGBL7071C6	RJ45 CAT6 UTP single §	10
GGBL7071C6S	RJ45 CAT6 UTP single - display packaged §	10
GGBL7072C6	RJ45 CAT6 UTP twin §	10
GGBL7072C6S	RJ45 CAT6 UTP twin - display packaged §	10

# TV outlets

## Coaxial sockets



GGBL7010



GGBL7020



GGBL7030

Product code	Description	Pack qty
GGBL7010	TV/R	10
GGBL7010S	TV/R - display packaged	10
GGBL7020	Diplex TV-R/DAB	10
GGBL7020S	Diplex TV-R/DAB - display packaged	10
GGBL7030	Satellite "F" Type	10
GGBL7030S	Satellite "F" Type - display packaged	10

- **Standard of compliance:**  
BS 3041 (where applicable)
- **Mounting box:**  
25mm deep for GGBL7010(S), GGBL7030(S)  
35mm deep for GGBL7020(S)
- **Fixing screws:**  
M3.5 x 18 mm for GGBL7010(S) and GGBL7030(S)  
M3.5 x 25 mm for GGBL7020(S)
- **Plate dimensions:**  
87 x 87mm



# Combination plates

## Quadplex combination



GGBL7074 GGBL707445511



GGBL70746110

Product code	Description	Pack qty
GGBL7074	Quadplex TV-R/DAB & 2 x SAT	10
GGBL7074S	Quadplex TV-R/DAB & 2 x SAT - display packaged	10
GGBL707445510	Quadplex RJ45 CAT5e & TV return	5
GGBL707445510S	Quadplex RJ45 CAT5e & TV return - display packaged	5
GGBL707445511	Quadplex RJ45 CAT5e & RJ12	5
GGBL707445511S	Quadplex RJ45 CAT5e & RJ12 - display packaged	5
GGBL70746110	Quadplex BT secondary & TV return	5
GGBL70746110S	Quadplex BT secondary & TV return - display packaged	5

- **Standard of compliance:** BS EN 5733
- **Mounting box:** 35mm deep
- **Fixing screws:** M3.5 x 25mm
- **Plate dimensions:** 87 x 87mm (1 gang)  
87 x 148.5mm (2 gang)

## Triplex combination



GGBL7081 GGBL7081456

Product code	Description	Pack qty
GGBL7081	Triplex TV-R/DAB & SAT	10
GGBL7081S	Triplex TV-R/DAB & SAT - display packaged	10
GGBL7081456	Triplex TV-R/DAB & RJ45 CAT6 UTP	5
GGBL7081456S	Triplex TV-R/DAB & RJ45 CAT6 UTP - display packaged	5

## Socket & media combination plate



GGBL3020D4MP

Product code	Description	Pack qty
GGBL3020D4MP	2 x 2 gang 13A socket, 2 x 2 module euro outlets, quadplex, BT secondary & TV return **	1

- **Standard of compliance:** BS5733
- **Dimensions:** 174 x 295mm
- **Mounting box:** GGBSB4724M (dimensions: 160 x 270 x 47mm depth)
- **Fixing screws:** M3.5 x 25mm
- **Plate dimensions:** 87 x 87mm (1 gang)  
87 x 148.5mm (2 gang)
- \*\* Product available from September 2015.

# Frames, blank plates & accessories

## Frames & surrounds



GGBLC1GS GGBLH1GS



GGBLSHF2GS GGBLSPC1FO

Product code	Description	Pack qty
GGBLSPC1FO	1 gang flex outlet frame	10
GGBLH1GS	1 gang surround with hook - display packaged	10
GGBLC1GS	1 gang surround with clip - display packaged	10
GGBLSHF2GS	2 gang surround with shelf - display packaged	10

- **Standard of compliance:** BS EN 5733
- **Fixing screws:** GGBLSPC1FO is supplied with cable clamp and fix screws M3.5 x 30 mm
- **Plate dimensions:** 87 x 87mm (1 gang)  
87 x 148.5mm (2 gang)

\*\* Product available from September 2015.

## Spacers & accessories



GGBLSPC1 GGBLSPC2

Product code	Description	Pack qty
GGBLSPC1	1 gang spacer	10
GGBLSPC1S	1 gang spacer - display packaged	10
GGBLSPC2	2 gang spacer	5
GGBLSPC2S	2 gang spacer - display packaged	10

# Frames, blank plates & accessories continued

## Blank plates & accessories



Product code	Description	Pack qty
GGBL8010	1 gang	10
GGBL8010S	1 gang - display packaged	10
GGBL8020	2 gang	5
GGBL8020S	2 gang - display packaged	10
GUMSCO	White moulded screw cap covers	100
GGBLSIND	LED indicators	5
USCREW50SS	M3.5 x 50mm screws	100
3746130	M3.5 x 25mm raised head machine screws	100

- **Standard of compliance:**  
BS EN 5733
- **Fixing screws:**  
M3.5 x 18mm (blank plates only)
- **Plate dimensions:**  
87 x 87mm (1 gang)  
87 x 148.5mm (2 gang)

## Grid plates

### 88 x 88mm



Product code	Description	Pack qty
GGBL01G	1 gang	5
GGBL02G	2 gang	5
GBG01	76 x 76 x 42mm flush mounted back box	1

- **Mounting box:**  
42mm deep
- **Fixing screws:**  
M3.5 x 30mm

### 88 x 148mm



Product code	Description	Pack qty
GGBL03G	3 gang	5
GGBL04G	4 gang	5
GBG02	136 x 76 x 42mm flush mounted back box	1

### 156 x 156mm



Product code	Description	Pack qty
GGBL06G	6 gang	1
GGBL08G	8 gang	1
GBG03	136 x 136 x 42mm flush mounted back box	1

## White moulded grid modules

### Switch modules



Product code	Description	Pack qty
GGBL102W	10AX 2 way	1
GGBL101W	10AX intermediate	1
GGBL201W	20AX 1 way	1
GGBL202W	20AX 2 way	1
GGBL20DPW	20AX double-pole	1
GGBL2011	20AX double-pole with neon	1

- **Standard of compliance:**  
BS EN 60669-1 (switch modules)  
BS 5733 (indicator modules)  
BS EN 41003 (fused connection units)
- **Mounting box:**  
42mm deep

# White moulded grid modules

## 20AX DP printed switch modules

Product code	Description	Pack qty
GGBL20DPMWW	Printed microwave	1
GGBL20DPCHW	Printed cooker hood	1
GGBL20DPDWW	Printed dishwasher	1
GGBL20DPFZW	Printed freezer	1
GGBL20DPWMW	Printed washing machine	1
GGBL20DPTDW	Printed tumble dryer	1
GGBL20DPHTW	Printed heater	1
GGBL20DPOVW	Printed oven	1
GGBL20DPEFW	Printed extractor fan	1
GGBL20DPFAW	Printed fan	1
GGBL20DPFFZW	Printed fridge freezer	1
GGBL20DPFRW	Printed fridge	1
GGBL20DPHOW	Printed hob	1

- **Standard of compliance:**  
BS EN 60669-1 (switch modules)  
BS 5733 (indicator modules)  
BS EN 41003 (fused connection units)

- **Mounting box:**  
42mm deep

\*\* Product available from September 2015.

## Retractive switch modules



GGBL202OCW

Product code	Description	Pack qty
GGBL102RW	10AX 2 way	1
GGBL202OCW	10AX 2 way & centre off	1
GGBL2020W	20AX 2 way centre off & on	1

## Key switch modules



GGBL202KEPWPW

Product code	Description	Pack qty
GGBL202KEPWPW	20AX 2 way	1
GGBL20DPKWPPW	20AX double-pole	1

## Fused connection unit, USB charger & blank modules



GGBL13FCUWPW



GGBLBW

Product code	Description	Pack qty
GGBL13FCUWPW	13A fused connection unit	1
GGBLE7004	USB charger **	1
GGBLE7004S	USB charger - display packaged **	1
GGBLBW	Blank	1

# White moulded grid modules continued

## Indicator modules



Product code	Description	Pack qty
GGBLINDWG	Green indicator	1
GGBLINDWR	Red indicator	1
GGBLINDWO	Orange indicator	1

- **Standard of compliance:**  
BS EN 60669-1  
(switch modules)  
BS 5733  
(indicator modules)  
BS EN 41003 (fused connection units)
- **Mounting box:**  
42mm deep

# Euro plates & modules

## Euro plates



Product code	Description	Pack qty
GGBL8050	1 gang 1 module	10
GGBL8060	1 gang 2 module	10
GGBL8080	2 gang 4 module	5

- **Mounting box:**  
35mm deep
- **Fixing screws:**  
M3.5 x 30mm
- **Plate dimensions:**  
87 x 87mm (1 gang)  
87 x 148.5mm (2 gang)

## 25 x 50mm euro modules



Product code	Description	Pack qty
GUE7011W	Single IEC coax (female)	1
GUE7012W	Single IEC coax (male)	1
GUE7030W	Single F type sat	1
GUE7061W	BT master telephone	1
GUE7062W	BT secondary telephone	1
GUE7071W	RJ45 CAT5e (not screened)	1
GUE7072W	RJ45 CAT6 (not screened)	1
GUE7051W	RJ11 modem	1
GUE7075W	VGA	1
GUE7091W	LexCom Performance outlet	8
GUE7000W	2 x Phono socket	1
GUE7001W	2 x Loudspeaker socket	1
GUE8010W	Blank module	5
GUE7073W	1A USB charger	1

## 50 x 50mm euro modules



Product code	Description	Pack qty
GUE7010W	TV/FM diplexer	1
GUE7040W	TV/Sat diplexer	1
GUE7081W	TV/FM/Sat triplexer	1
GUE7082W	TV/FM/Sat1/Sat2 quadplexer	1
GUE7020W	HDMI	1
GUE7074W	2 x 1A USB charger	1

# Surface pattresses

## 1 gang



GGBL9116 GGBL9147

Product code	Description	Pack qty
GGBL9116	1 gang 16mm	10
GGBL9116S	1 gang 16mm - display packaged	10
GGBL9125	1 gang 25mm	10
GGBL9125S	1 gang 25mm - display packaged	10
GGBL9147	1 gang 40mm	10
GGBL9147S	1 gang 40mm - display packaged	10

- **Standard of compliance:**  
BS 5733
- **Technical notes:**  
All supplied complete with earth terminals.

## Surface 2 gang



GGBL9225

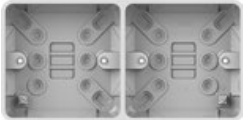

GGBL9D25



GGBL9247

Product code	Description	Pack qty
GGBL9225	2 gang 25mm	5
GGBL9225S	2 gang 25mm - display packaged	5
GGBL9D25	2 gang dual 25mm	5
GGBL9D25S	2 gang dual 25mm - display packaged	5
GGBL9247	2 gang 40mm	5
GGBL9247S	2 gang 40mm - display packaged	5

## Architrave



GGBL9216A

Product code	Description	Pack qty
GGBL9116A	1 gang 16mm	10
GGBL9216A	2 gang 16mm	10

# Flush galvanised steel boxes

## 16mm deep



SB161

Product code	Description	Pack qty
SB161	1 gang	20

- **Standard of compliance:**  
BS 4662

- **Technical notes:**  
Supplied with earth terminal and screw.

## 25mm deep

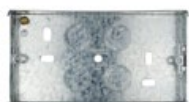

SB252

Product code	Description	Pack qty
SB251	1 gang	10
SB252	2 gang	10

Supplied with fixed and adjustable lugs.

Fitted with selection of 20mm knockouts in sides and back.

## 35mm deep



SB351

Product code	Description	Pack qty
SB351	1 gang	10
SB352	2 gang	5

## 47mm deep



SB472

Product code	Description	Pack qty
SB471	1 gang	10
SB472	2 gang	4



EXCLUSIVE





# Meeting all of your needs

The Exclusive range of wiring accessories offers the dependability that you need along with increased flexibility in applications, whether those are installations in the residential and commercial space or in outdoor and industrial environments.



## Square edge white moulded

This comprehensive white moulded range will offer everything that your customers need in a traditional wiring accessory. With its classic, square edge design, the Exclusive white moulded range will suite well with existing installations and is sure to please again and again.



## Decorative

Delight your customers with the classic elegance of the Exclusive decorative range. With its quality Polished Chrome and Matt Chrome metal finishes, this range is ideal for customers desiring an upgraded aesthetic to the traditional, square edge design.



## Metal clad

Looking for stronger stuff? The Exclusive metal clad range of wiring accessories offers an incredibly robust solution for industrial applications, with two finish options - Grey and Silver Grey.

# Exclusive square edge white moulded

This highly successful Exclusive square edge range of white moulded wiring accessories maintains superb quality, with an easy-to-install technical specification, for exceptional value for money.

Optional cable outlet facility provides the choice of either surface or flush cable access

Full 10AX plate switch rating for fluorescent and inductive loads

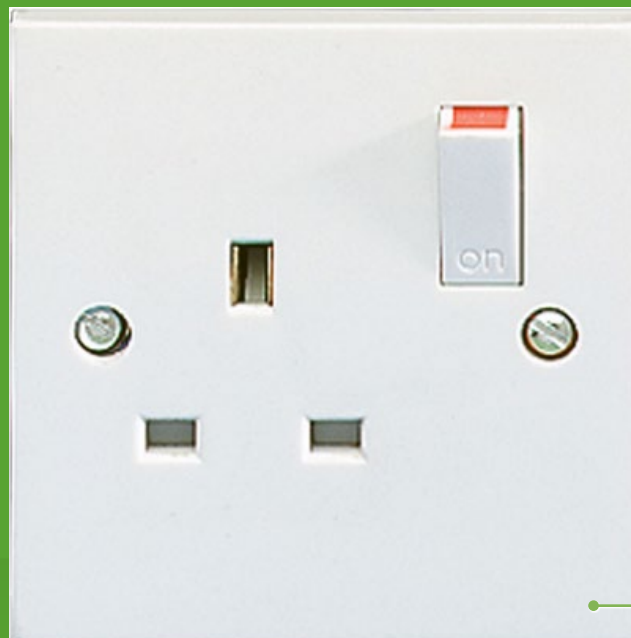

50A rated switches for operating appliances with higher current ratings, such as heaters, cookers and commercial refrigerating units

Timeless and traditional plate profile, with generous 9mm plate depth

**Double pole sockets provide both easy access to connections as well as twin earth terminals for high integrity earthing**

Residual current devices with active and passive controls offer added safety in the event of lost power:

- **Passive Latching:** Designed for food freezers or garden water feature pumps, ensuring that contacts will stay closed during loss of power so that RCD does not need re-setting when the circuit is restored.
- **Active / non-latching:** Designed for lawnmowers or power tools, the RCD will tip on loss of power and requires manual resetting when the circuit is to be re-energised.

## Converta Socket Outlets

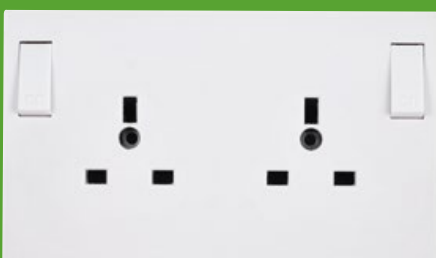

A converta socket outlet is an ideal retrofit solution for existing installations. The device allows single to double conversion of standard flush-mounted wiring accessories without the need for additional cabling or chasing.

- Allows 2 gang socket to fit 1 gang steel back box
- Quick and easy replacement, saving time and money
- Reduces the need for redecorating



# Socket outlets

## 1 3A unswitched

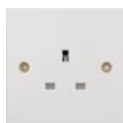

GSKT1G



GSKT2G

Product code	Description	Pack qty
GSKT1G	1 gang	10
GSKT2G	2 gang	5

- **Standard of compliance:**  
BS 1363 (13A)  
BS 546 (round pin)  
BS 7288 (RCD)
- **Mounting box:**  
Minimum 25mm deep
- **Fixing screws:**  
M3.5 x 30mm
- **Plate dimensions:**  
86 x 86mm (1 gang)  
86 x 146mm (2 gang)
- **Technical notes:**  
**Active control** - device will fail safe in the event of loss of supply. Suitable for domestic use.

## 1 3A switched



GSKTSW1G



GSKTSW2G2

Product code	Description	Pack qty
GSKTSW1G	1 gang single-pole	10
GSKTSWDP1G	1 gang double-pole	10
GSKTSW2G2	2 gang single-pole	5
GSKTSWDP2G	2 gang double-pole	5
GSKTSW3G	3 gang single-pole with fuse	5

**Passive control** - device will only trip in the event of a fault. Suitable for freezers and commercial applications.

All 2 gang sockets include twin earth terminals as standard, enabling high integrity earthing.

## 1 3A double-pole switched with outboard rockers



GSKTSWDPOB2G



GSKTSWDP1G2G

Product code	Description	Pack qty
GSKTSWDPOB2G	2 gang	5
GSKTSWDP1G2G	1-2 gang converta	5

## Round pin



GSKT2A1G



GSKT5A1G



GSKTSW15A1G

Product code	Description	Pack qty
GSKT2A1G	2A unswitched	10
GSKT5A1G	5A unswitched	10
GSKT15A1G	15A unswitched	10
GSKTSW15A1G	15A switched	10

## Double-pole 30mA RCD protected



GPRCDSKT2G

Product code	Description	Pack qty
LSKT1GR	1 gang unswitched - active control	1
GPRCDSKT1G	1 gang switched - passive control	1
LSKT2GR	2 gang unswitched - active control	1
LSKT2GRP	2 gang unswitched - passive control	1
GPRCDSKT2G	2 gang switched - passive control	1

# Plate switches

## 10AX 1 gang



GSW1G2W

Product code	Description	Pack qty
GSW1G1W	1 gang 1 way	10
GSW1G2W	1 gang 2 way	10
GSWINT	Intermediate	10

- Standard of compliance:**  
 BS EN 60669-1  
 BS EN 60947-3  
 (GSWISO2)  
 BS 3676  
 (GSWTPS)
- Mounting box:**  
 16mm deep (1-2 gang)  
 25mm deep (3-6 gang)
- Fixing screws:**  
 M3.5 x 18mm
- Plate dimensions:**  
 86 x 86mm (1-3 gang)  
 86 x 146mm (4 gang)  
 33 x 86mm (1 gang  
 architrave)  
 33 x 148mm (2 gang  
 architrave)

## 10A 1 gang 2 way retractive



GSW1G2WRP GSW1G2WRB

Product code	Description	Pack qty
GSW1G2WR	1 gang 2 way	10
GSW1G2WRP	1 gang 2 way printed with press	10
GSW1G2WRB	1 gang 2 way printed with bell symbol	10

## 10AX multi gang



GSW2G2W GSW3G2W



GSW4G2W

Product code	Description	Pack qty
GSW2G2W	2 gang 2 way	10
GSW3G2W	3 gang 2 way	10
GSW4G2W	4 gang 2 way	10

## 10A triple pole isolator



GSWTPS GSWISO2

Product code	Description	Pack qty
GSWTPS	Triple pole switch	10
GSWISO2	3 pole lockable isolator	10

## 10AX architrave



GSWA1G2W

GSWA2G2W

Product code	Description	Pack qty
GSWA1G2W	1 gang 2 way	10
GSWA2G2W	2 gang 2 way	10

# Dimmer switches

## 1 gang



GD1G2WC

Product code	Description	Pack qty
GD1G1W	60-250W 1 way mains	1
GD1G2WC	250W/VA 2 way mains & low voltage	1
GD1G2W4C	400W/VA 2 way mains & low voltage	1

## 2 gang



GD2G2WC

Product code	Description	Pack qty
GD2G2WC	250W/VA 2 way mains & low voltage	1

- **Standard of compliance:**  
BS EN 60669-2-1
- **Mounting box:**  
16mm (GD1G1W)  
25mm deep
- **Fixing screws:**  
M3.5 x 30mm
- **Plate dimensions:**  
86 x 86mm (1 gang)  
86 x 146mm (2 gang)
- **Technical notes:**  
Not suitable for dimming  
LED or CFL lighting.

# Control switches & flex outlet plates

## 20AX DP 1 gang switched



GSWDP20AHT



GSWDPN20A

Product code	Description	Pack qty
GSWDP20A	1 gang	10
GSWDP20AHT	1 gang engraved heater	10
GSWDP20AOV	1 gang engraved oven	10
GSWDPN20A	1 gang with neon	10
GSWDPN20AHT	1 gang with neon engraved heater	10
GSWDPN20AOV	1 gang with neon engraved oven	10

- **Standard of compliance:**  
BS EN 60669-1
- **Mounting box:**  
25mm deep
- **Fixing screws:**  
M3.5 x 30mm
- **Plate dimensions:**  
86 x 86mm

## 20AX DP 1 gang switched with flex outlet



GSWDP20AFO



GSWDP20AFOTR

Product code	Description	Pack qty
GSWDP20AFO	1 gang	10
GSWDP20AFOAC	1 gang engraved air conditioner	10
GSWDP20AFOHT	1 gang engraved heater	10
GSWDP20AFOTR	1 gang engraved towel rail	10

## 20AX DP 1 gang switched with neon & flex outlet



GSWDPN20AFO



GSWDPN20AFOWH

Product code	Description	Pack qty
GSWDPN20AFO	1 gang	10
GSWDPN20AFOAC	1 gang engraved air conditioner	10
GSWDPN20AFOHT	1 gang engraved heater	10
GSWDPN20AFOTR	1 gang engraved towel rail	10
GSWDPN20AFOWH	1 gang engraved water heater	10

## Flex outlet plates



Product code	Description	Pack qty
GSFOPATE	25A side entry	10
GFOPLATE	20A front entry	10

- **Standard of compliance:** BS 5733
- **Mounting box:** 25mm deep
- **Fixing screws:** M3.5 x 30mm
- **Plate dimensions:** 86 x 86mm

## Fused connection units

## Unswitched



Product code	Description	Pack qty
GSPUR3A	3A	10
GSPUR	13A	10
GNSPUR	13A with neon	10

- **Standard of compliance:** BS 1363
- **Mounting box:** 25mm deep
- **Fixing screws:** M3.5 x 30mm
- **Plate dimensions:** 86 x 86mm
- **Technical note:** Optional flex outlet facility at the base of the front plate

## 1 3A DP switched with optional flex outlet



Product code	Description	Pack qty
GSWSPUR	13A DP	10
GSWSPURWM	13A DP engraved washing machine	10
GSWSPURBO	13A DP engraved boiler	10
GSWSPURCH	13A DP engraved cooker hood	10
GSWSPURDW	13A DP engraved dish washer	10
GSWSPUREF	13A DP engraved extractor fan	10
GSWSPURFA	13A DP engraved fan	10
GSWSPURFZ	13A DP engraved freezer	10
GSWSPURFR	13A DP engraved fridge	10
GSWSPURFFZ	13A DP engraved fridge/freezer	10
GSWSPURHO	13A DP engraved hob	10
GSWSPURHT	13A DP engraved heater	10
GSWSPURMW	13A DP engraved microwave	10
GSWSPURTD	13A DP engraved tumble dryer	10
GSWSPURWD	13A DP engraved waste disposal	10
GSWSPURWDY	13A DP engraved washer dryer	10

## Fused connection units continued

### 1 3A DP switched with neon & optional flex outlet



GSWNSPUR GSWNSPURFR



GSWNSPURMW

Product code	Description	Pack qty
GSWNSPUR	13A DP	10
GSWNSPURWM	13A DP engraved washing machine	10
GSWNSPURBO	13A DP engraved boiler	10
GSWNSPURCH	13A DP engraved cooker hood	10
GSWNSPURDW	13A DP engraved dish washer	10
GSWNSPUREF	13A DP engraved extractor fan	10
GSWNSPURFA	13A DP engraved fan	10
GSWNSPURFZ	13A DP engraved freezer	10
GSWNSPURFR	13A DP engraved fridge	10
GSWNSPURFFZ	13A DP engraved fridge freezer	10
GSWNSPURHO	13A DP engraved hob	10
GSWNSPURHT	13A DP engraved heater	10
GSWNSPURMW	13A DP engraved microwave	10
GSWNSPURTD	13A DP engraved tumble dryer	10
GSWNSPURWD	13A DP engraved waste disposal	10
GSWNSPURWDY	13A DP engraved washer dryer	10

- **Standard of compliance:**  
BBS 1363  
BS 7288 (RCD)
- **Mounting box:**  
25mm deep
- **Fixing screws:**  
M3.5 x 30mm
- **Plate dimensions:**  
86 x 86mm

### Double-pole 30mA RCD protected



GPRCDFCU

Product code	Description	Pack qty
GPRCDFCU	Unswitched - passive control	1

## High current switches

### 50A DP switches



GCKRN50A GCKR50A2G

Product code	Description	Pack qty
GCKR50A	1 gang	5
GCKRN50A	1 gang with neon	5
GCKR50A2G	2 gang	5
GCKRN50A2G	2 gang with neon	5

- **Standard of compliance:**  
BS EN 60669-1 (switches)  
BS 4177 (cooker control units)  
BS 5733
- **Mounting box:**  
40mm deep
- **Fixing screws:**  
M3.5 x 30mm
- **Plate dimensions:**  
86 x 86mm (1 gang)  
146 x 86mm (2 gang)

### 45A cooker control unit with 1 3A switched socket



G45ACCUN

Product code	Description	Pack qty
G45ACCU	45A cooker control unit	1
G45ACCUN	45A cooker control unit with neons	1



## Cooker connection unit



G45CX

Product code	Description	Pack qty
G45CX	Cooker connection unit	10

## Shaver socket

## 115/230V dual voltage



GSHVSKT



GADAPTSVR

Product code	Description	Pack qty
GSHVSKT	Dual voltage 115/230V socket	1
GADAPTSVR	Adapter with 1A fuse	20

- **Standard of compliance:**  
BS EN 61558-2-5  
BS 646 (fuse)
- **Mounting box:**  
40mm deep
- **Fixing screws:**  
M3.5 x 30mm
- **Plate dimensions:**  
146 x 86mm

## Telephone &amp; data outlets

## Telephone outlets



GTELRJ11



GTELMAS

Product code	Description	Pack qty
GTELRJ11	RJ11 outlet	10
GTELMAS	BT master	10
GTELSEC	BT secondary	10

- **Standard of compliance:**  
BS EN 41003
- **Mounting box:**  
25mm deep
- **Fixing screws:**  
M3.5 x 30mm
- **Plate dimensions:**  
86 x 86mm

## RJ45 CAT5e UTP



GTELRJ45

Product code	Description	Pack qty
GTELRJ45	RJ45 CAT5e UTP	10

## TV outlets

## Coaxial sockets



GSKTCOAX



GSKTCOAX2G

Product code	Description	Pack qty
GSKTCOAX	Single direct connection TV	10
GSKTCOAX2G	Twin direct connection TV	10

- **Standard of compliance:**  
BS 3041 (where applicable)
- **Mounting box:**  
25mm deep
- **Fixing screws:**  
M3.5 x 30mm
- **Plate dimensions:**  
86 x 86mm

# Blank plates & accessories

## Blank plates & machine screws



GBLANK1G



GBLANK2G

Product code	Description	Pack qty
GBLANK1G	1 gang	10
GBLANK2G	2 gang	5
USCREW50SS	M3.5 x 50mm screws	100
3746130	M3.5 x 25mm raised head machine screws	100

- **Standard of compliance:**  
BS EN 5733
- **Fixing screws:**  
M3.5 x 30mm
- **Plate dimensions:**  
86 x 86mm (1 gang)  
86 x 146mm (2 gang)

# Euro modular plates & modules

## Euro plates



GEURO1

GEURO2

Product code	Description	Pack qty
GEURO1	1 gang 1 module	10
GEURO2	1 gang 2 module	10
GEURO4	2 gang 4 module	5

- **Mounting box:**  
35mm deep
- **Fixing screws:**  
M3.5 x 30mm
- **Plate dimensions:**  
86 x 86mm (1 gang)  
86 x 146mm (2 gang)

## 25 x 50mm euro modules



GUE7011W



GUE7061W

Product code	Description	Pack qty
GUE7011W	Single IEC coax (female)	1
GUE7012W	Single IEC coax (male)	1
GUE7030W	Single F type sat	1
GUE7061W	BT master telephone	1
GUE7062W	BT secondary telephone	1
GUE7071W	RJ45 CAT5e (not screened)	1
GUE7072W	RJ45 CAT6 (not screened)	1
GUE7051W	RJ11 modem	1
GUE7075W	VGA	1
GUE7091W	LexCom Performance outlet	8
GUE7000W	2 x Phono socket	1
GUE7001W	2 x Loudspeaker socket	1
GUE8010W	Blank module	5
GUE7073W	1A USB charger	1

## 50 x 50mm euro modules



GUE7010W

GUE7081W



GUE7020W

Product code	Description	Pack qty
GUE7010W	TV/FM diplexer	1
GUE7040W	TV/Sat diplexer	1
GUE7081W	TV/FM/Sat triplexer	1
GUE7082W	TV/FM/Sat1/Sat2 quadplexer	1
GUE7020W	HDMI	1
GUE7074W	2 x 1A USB charger	1

# Surface pattresses

## 1 gang



GPAT1G16

Product code	Description	Pack qty
GPAT1G16	1 gang 16mm	10
GPAT1G25	1 gang 25mm	10
GPAT1G47	1 gang 40mm	10

## 2 gang



GPAT2G25

Product code	Description	Pack qty
GPAT2G25	2 gang 25mm	5
GPATDG25	2 gang dual 25mm	10
GPAT2G47	2 gang 40mm	5

## Architrave



GPAT1G16A

Product code	Description	Pack qty
GPAT1G16A	1 gang 16mm	20
GPAT2G16A	2 gang 16mm	10

## Converter



GPAT2GC25

Product code	Description	Pack qty
GPAT2GC25	1-2 gang 25mm	5
GPAT3G25	1-3 gang 25mm	5



GPAT3G25

- **Technical notes:**  
GPAT3G25 is designed for us with GSKTSW3G.

# Flush galvanised steel boxes

## 16mm deep



SB161

Product code	Description	Pack qty
SB161	1 gang	20

- **Standard of compliance:**  
BS 4662

- **Technical notes:**  
Supplied with earth terminal and screw.

## 25mm deep

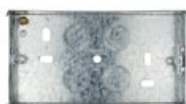

SB252

Product code	Description	Pack qty
SB251	1 gang	10
SB252	2 gang	10

Supplied with fixed and adjustable lugs.

Fitted with selection of 20mm knockouts in sides and back.

## 35mm deep



SB351

Product code	Description	Pack qty
SB351	1 gang	10
SB352	2 gang	5

## 47mm deep



SB472

Product code	Description	Pack qty
SB471	1 gang	10
SB472	2 gang	4



# Exclusive Decorative

The classic and elegant Exclusive Decorative range, with its traditional, square edge plate profile offers a trusted design that withstands the test of time.

Timeless and traditional plate profile suitable for both domestic and commercial use

50A rated plate switches for switching appliances with higher current ratings, such as heaters, cookers and commercial refrigerating units

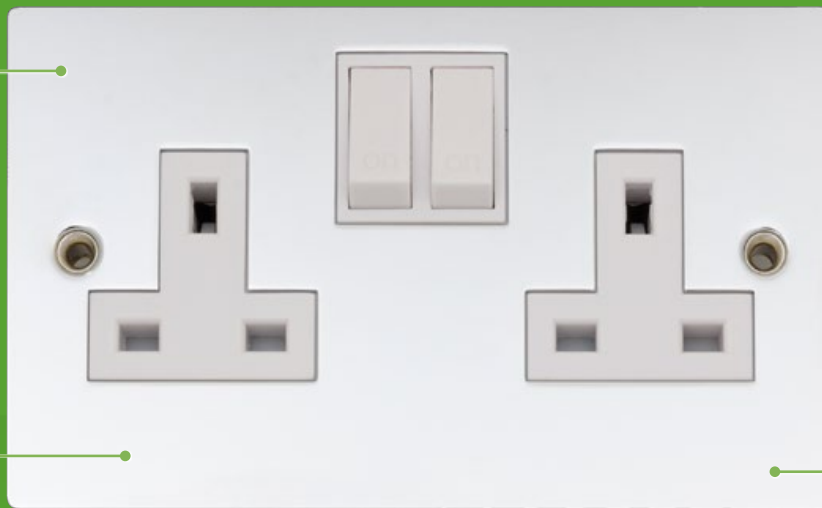

9mm plate depth for an easy installation

Full 10AX plate switch rating for fluorescent and inductive loads

## Finish Selection

The Exclusive Decorative range is available in Matt Chrome or Polished Chrome finishes, both with white interiors.





# Socket outlets

## 1 3A 1 gang single-pole unswitched



GEP3550WMC

Product code	Description	Pack qty
GEP3550WMC	Matt chrome	1

## 1 3A 2 gang single-pole unswitched



GEP3560WMC

Product code	Description	Pack qty
GEP3560WMC	Matt chrome	1

## 1 3A 1 gang single-pole switched



GEP3510WPC

Product code	Description	Pack qty
GEP3510WMC	Matt chrome	1
GEP3510WPC	Polished chrome	1

## 1 3A 2 gang single-pole switched



GEP3520WPC

Product code	Description	Pack qty
GEP3520WMC	Matt chrome	1
GEP3520WPC	Polished chrome	1

## 5A unswitched round pin



GEP3580WPC

Product code	Description	Pack qty
GEP3580WMC	Matt chrome	1
GEP3580WPC	Polished chrome	1

- **Standard of compliance:**  
BS 1363 (13A)  
BS 546 (round pin)
- **Mounting box:**  
Minimum 25mm deep
- **Fixing screws:**  
M3.5 x 30mm
- **Plate dimensions:**  
95 x 95mm (1 gang)  
95 x 154.5mm (2 gang)
- **Technical notes:**  
All 2 gang sockets supplied with twin earth terminals as standard, for high integrity earthing.

## Finish Selection



Matt chrome



Polished chrome



# Plate switches

## 10AX 1 gang 2 way



GEP1512WPC

Product code	Description	Pack qty
GEP1512WMC	Matt chrome	1
GEP1512WPC	Polished chrome	1

- **Standard of compliance:**  
BS EN 60669-1  
BS EN 60947-3  
(GEP1513\*\*\*)

- **Mounting box:**  
16mm deep (1-2 gang)  
25mm deep (3-4 gang)

- **Fixing screws:**  
M3.5 x 25mm

- **Plate dimensions:**  
95 x 95mm (1-3 gang)  
95 x 154.5mm (4 gang)

## 10AX 1 gang intermediate



GEP1514WPC

Product code	Description	Pack qty
GEP1514WMC	Matt chrome	1
GEP1514WPC	Polished chrome	1

## 10AX 2 gang 2 way



GEP1522WPC

Product code	Description	Pack qty
GEP1522WMC	Matt chrome	1
GEP1522WPC	Polished chrome	1

## 10AX 3 gang 2 way



GEP1532WPC

Product code	Description	Pack qty
GEP1532WMC	Matt chrome	1
GEP1532WPC	Polished chrome	1

## 10AX 4 gang 2 way



GEP1542WPC

Product code	Description	Pack qty
GEP1542WMC	Matt chrome	1
GEP1542WPC	Polished chrome	1

## 10A triple pole isolator



GEP1513WPC

Product code	Description	Pack qty
GEP1513WMC	Matt chrome	1
GEP1513WPC	Polished chrome	1

## Finish Selection



Matt chrome



Polished chrome

## Toggle switches

10AX 1 gang 2 way



GEP1512TPC

Product code	Description	Pack qty
GEP1512TMC	Matt chrome	1
GEP1512TPC	Polished chrome	1

- **Standard of compliance:**  
BS EN 60669-1
- **Mounting box:**  
16mm
- **Fixing screws:**  
M3.5 x 25mm
- **Plate dimensions:**  
95 x 95mm

10AX 2 gang 2 way



GEP1522TPC

Product code	Description	Pack qty
GEP1522TMC	Matt chrome	1
GEP1522TPC	Polished chrome	1

## Dimmer switches

1 gang 2 way 400W mains



GEP6512PC

Product code	Description	Pack qty
GEP6512MC	Matt chrome	1
GEP6512PC	Polished chrome	1

- **Standard of compliance:**  
BS EN 60669-2-1
- **Mounting box:**  
25mm deep
- **Fixing screws:**  
M3.5 x 30mm
- **Plate dimensions:**  
95 x 95mm
- **Technical notes:**  
All dimmers not suitable with CFL or LED lighting.

2 gang 2 way 250W mains



GEP6522PC

Product code	Description	Pack qty
GEP6522MC	Matt chrome	1
GEP6522PC	Polished chrome	1

- Leading edge control.
- Not suitable on low voltage circuits.

## Control switches

20AX double-pole 1 gang switched



GEP2510WPC

Product code	Description	Pack qty
GEP2510WMC	Matt chrome	1
GEP2510WPC	Polished chrome	1

- **Standard of compliance:**  
BS EN 60669-1
- **Mounting box:**  
25mm deep
- **Fixing screws:**  
M3.5 x 30mm
- **Plate dimensions:**  
95 x 95mm

20AX double-pole 1 gang switched with neon



GEP2511WPC

Product code	Description	Pack qty
GEP2511WMC	Matt chrome	1
GEP2511WPC	Polished chrome	1

## Fused connection units

### 1 3A unswitched



GEP5500WPC

Product code	Description	Pack qty
GEP5500WMC	Matt chrome	1
GEP5500WPC	Polished chrome	1

- **Standard of compliance:** BS 1363
- **Mounting box:** 25mm deep
- **Fixing screws:** M3.5 x 30mm
- **Plate dimensions:** 95 x 95mm

### 1 3A double-pole unswitched with neon



GEP5501WPC

Product code	Description	Pack qty
GEP5501WMC	Matt chrome	1
GEP5501WPC	Polished chrome	1

### 1 3A DP switched



GEP5510WPC

Product code	Description	Pack qty
GEP5510WMC	Matt chrome	1
GEP5510WPC	Polished chrome	1

### 1 3A DP switched with neon



GEP5511WPC

Product code	Description	Pack qty
GEP5511WMC	Matt chrome	1
GEP5511WPC	Polished chrome	1

## High current switches

### 50A 1 gang DP switch



GEP5020WPC

Product code	Description	Pack qty
GEP5020WMC	Matt chrome	1
GEP5020WPC	Polished chrome	1

- **Standard of compliance:** BS EN 60669-1 (switches)  
BS 4177 (cooker control units)
- **Mounting box:** 47mm deep
- **Fixing screws:** M3.5 x 30mm
- **Plate dimensions:** 95 x 95mm (1 gang)  
95 x 154.5mm (2 gang)

### 50A 1 gang DP switch with neon



GEP5021WPC

Product code	Description	Pack qty
GEP5021WMC	Matt chrome	1
GEP5021WPC	Polished chrome	1

### 45A DP cooker control unit with 1 3A switched socket & neons



GEP4501WPC

Product code	Description	Pack qty
GEP4501WMC	Matt chrome	1
GEP4501WPC	Polished chrome	1

# Shaver socket

115/230V dual voltage



GEP7590WPC

Product code	Description	Pack qty
GEP7590WMC	Matt chrome	1
GEP7590WPC	Polished chrome	1

- **Standard of compliance:** BS EN 61558-2-5
- **Mounting box:** 47mm deep
- **Fixing screws:** M3.5 x 30mm
- **Plate dimensions:** 95 x 154.5mm

# Telephone outlets

BT master



GEP7561WPC

Product code	Description	Pack qty
GEP7561WMC	Matt chrome	1
GEP7561WPC	Polished chrome	1

- **Standard of compliance:** BS EN 41003
- **Mounting box:** 25mm deep
- **Fixing screws:** M3.5 x 30mm
- **Plate dimensions:** 95 x 95mm

BT secondary



GEP7562WPC

Product code	Description	Pack qty
GEP7562WMC	Matt chrome	1
GEP7562WPC	Polished chrome	1

# TV outlets

Single TV/FM coaxial



GEP7510WPC

Product code	Description	Pack qty
GEP7510WMC	Matt chrome	1
GEP7510WPC	Polished chrome	1

- **Standard of compliance:** BS 3041 (where applicable)
- **Mounting box:** 35mm deep
- **Fixing screws:** M3.5 x 30mm
- **Plate dimensions:** 95 x 95mm

Diplex



GEP7521PC

Product code	Description	Pack qty
GEP7521MC	Matt chrome	1
GEP7521PC	Polished chrome	1

Triplex



GEP7581MC

Product code	Description	Pack qty
GEP7581MC	Matt chrome	1

# Blank plates & accessories

## 1 gang



GEP8510PC

Product code	Description	Pack qty
GEP8510MC	Matt chrome	1
GEP8510PC	Polished chrome	1

- **Standard of compliance:**  
BS EN 5733
- **Fixing screws:**  
M3.5 x 30mm
- **Plate dimensions:**  
95 x 95mm (1 gang)  
95 x 154.5mm (2 gang)

## 2 gang



GEP8520PC

Product code	Description	Pack qty
GEP8520MC	Matt chrome	1
GEP8520PC	Polished chrome	1
3746130	M3.5 x 25mm raised head machine screws	100
USCREW50SS	M3.5 x 50mm screws	100

# Flush galvanised steel boxes

## 16mm deep



SB161

Product code	Description	Pack qty
SB161	1 gang	20

- **Standard of compliance:**  
BS 4662
- **Technical notes:**  
Supplied with earth terminal and screw.

## 25mm deep

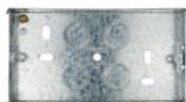

SB252

Product code	Description	Pack qty
SB251	1 gang	10
SB252	2 gang	10

Supplied with fixed and adjustable lugs.

Fitted with selection of 20mm knockouts in sides and back.

## 35mm deep



SB351

Product code	Description	Pack qty
SB351	1 gang	10
SB352	2 gang	5

## 47mm deep



SB472

Product code	Description	Pack qty
SB471	1 gang	10
SB472	2 gang	4

## Finish Selection



Matt chrome



Polished chrome

# Exclusive Metal clad

Our Exclusive metal clad range has been built to perform. The strong, industrial design supported by a robust technical specification makes this range the perfect choice for a variety of commercial and public buildings.

Popular trends in the domestic market for modern loft style interiors also provide the perfect backdrop for this range which is available in either grey or silver grey finishes.

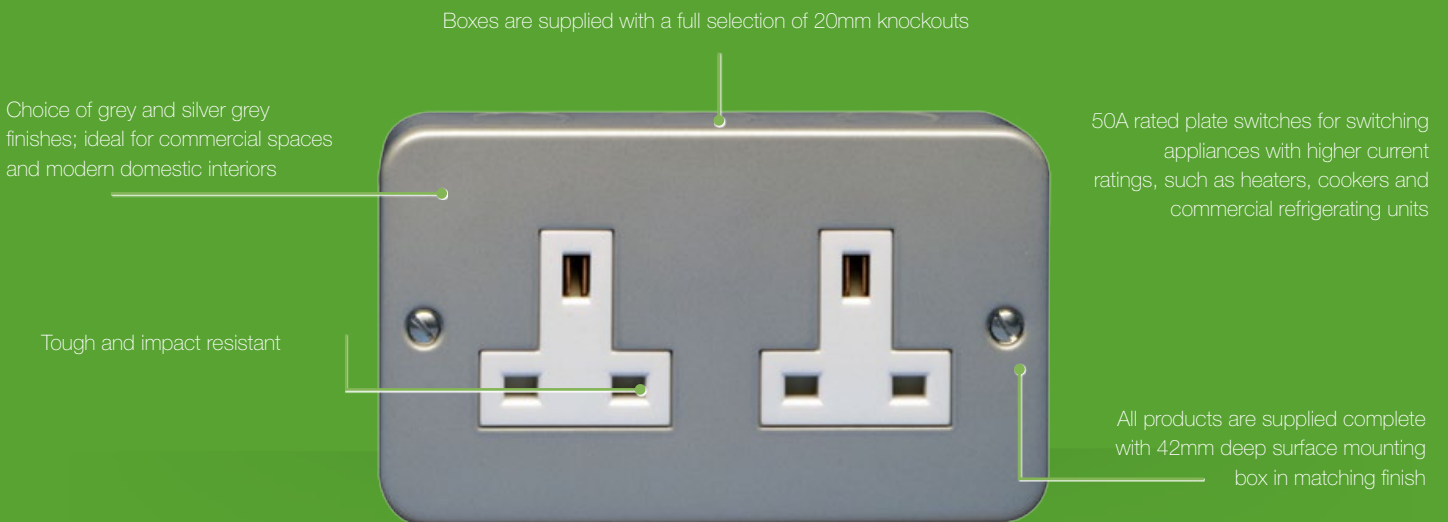

## Finish Selection

The Exclusive Metal Clad range is available in Silver Grey or Grey finishes





# Socket outlets

## 1 3A 1 gang unswitched



GMC131S

Product code	Description	Pack qty
GMC131S	Grey	10
GMCS131S	Silver Grey	10

## 1 3A 2 gang unswitched



GMC132S

Product code	Description	Pack qty
GMC132S	Grey	5
GMCS132S	Silver Grey	5

## 1 3A 1 gang single-pole switched



GMC131SS

Product code	Description	Pack qty
GMC131SS	Grey	10
GMCS131SS	Silver Grey	10

## 1 3A 2 gang single-pole switched



GMC132SS

Product code	Description	Pack qty
GMC132SS	Grey	5
GMCS132SS	Silver Grey	5

## 1 3A 2 gang single-pole switched with outboard rockers



GU3631GMC

Product code	Description	Pack qty
GU3631GMC	Grey	5

## 5A round pin unswitched



GMC51S

Product code	Description	Pack qty
GMC51S	Grey	10
GMCS51S	Silver Grey	10

## 1 gang double-pole 30mA RCD protected - active control



LMCSKT1GR

Product code	Description	Pack qty
LMCSKT1GR	Grey	1

- **Standard of compliance:**  
BS 1363 (13A)  
BS 546 (round pin)  
BS 7288 (RCD)
- **Mounting box:**  
40mm deep (back box supplied)
- **Fixing screws:**  
M3.5 x 30mm
- **Plate dimensions:**  
79 x 79 x 42mm (1 gang)  
79 x 139 x 42mm (2 gang)  
92 x 145 x 49mm (RCDs)
- **Technical notes:**  
LMCSKT1GR requires a 2 gang back box.

Active control consists of an electronic latch, which will require resetting in the event of a loss of supply. Particularly useful for domestic use.

Passive control - device will only trip in the event of a fault. Suitable for freezers and commercial applications.



## 1 gang double-pole 30mA RCD protected switched - passive control



GMCPRCDSKT1G

Product code	Description	Pack qty
GMCPRCDSKT1G	Grey	1

## 2 gang double-pole 30mA RCD protected - active control



LMCSKT2GR

Product code	Description	Pack qty
LMCSKT2GR	Grey	1

## 2 gang double-pole 30mA RCD protected switched - passive control



LMCSKT2GRP

Product code	Description	Pack qty
LMCSKT2GRP	Grey	1

## 2 gang double-pole 30mA RCD protected switched - passive control



GMCPRCDSKT2G

Product code	Description	Pack qty
GMCPRCDSKT2G	Grey	1

## Plate switches

## 10AX 1 gang 2 way



GMC1012

Product code	Description	Pack qty
GMC1012	Grey	10
GMCS1012	Silver Grey	10

- **Standard of compliance:** BS EN 60669-1
- **Mounting box:** 40mm deep (back box supplied)
- **Plate dimensions:** 79 x 79 x 42mm

## 10AX 1 gang intermediate



GMCINT

Product code	Description	Pack qty
GMCINT	Grey	10
GMCSINT	Silver Grey	10

## Plate switches continued

10AX 2 gang 2 way



GMC1022

Product code	Description	Pack qty
GMC1022	Grey	10
GMCS1022	Silver Grey	10

- **Standard of compliance:**  
BS EN 60669-1
- **Mounting box:**  
40mm deep (back box supplied)
- **Plate dimensions:**  
79 x 79 x 42mm

10AX 3 gang 2 way



GMC1032

Product code	Description	Pack qty
GMC1032	Grey	10
GMCS1032	Silver Grey	10

## Control switches

20AX double-pole 1 gang switched



GMC20S

Product code	Description	Pack qty
GMC20S	Grey	10
GMCS20S	Silver Grey	10

- **Standard of compliance:**  
BS EN 60669-1
- **Mounting box:**  
40mm deep (back box supplied)
- **Plate dimensions:**  
79 x 79 x 42mm

20AX double-pole 1 gang switched with neon



GMC20SN

Product code	Description	Pack qty
GMC20SN	Grey	10
GMCS20SN	Silver Grey	10

## Fused connection units

1 3A unswitched



GMC13SP

Product code	Description	Pack qty
GMC13SP	Grey	10
GMCS13SP	Silver Grey	10

- **Standard of compliance:**  
BS 1363
- **Mounting box:**  
40mm deep (back box supplied)
- **Plate dimensions:**  
79 x 79 x 42mm

1 3A unswitched with neon



GMC13SPN

Product code	Description	Pack qty
GMC13SPN	Grey	10
GMCS13SPN	Silver Grey	10

## 1 3A unswitched with flex outlet



GMC13SPF

Product code	Description	Pack qty
GMC13SPF	Grey	10
GMCS13SPF	Silver Grey	10

## 1 3A DP unswitched with neon &amp; flex outlet



GMC13SPNF

Product code	Description	Pack qty
GMC13SPNF	Grey	10
GMCS13SPNF	Silver Grey	10

## 1 3A double-pole switched



GMC13SSP

Product code	Description	Pack qty
GMC13SSP	Grey	10
GMCS13SSP	Silver Grey	10

## 1 3A double-pole switched with neon



GMC13SSPN

Product code	Description	Pack qty
GMC13SSPN	Grey	10
GMCS13SSPN	Silver Grey	10

## 1 3A double-pole switched with flex outlet



GMC13SSPF

Product code	Description	Pack qty
GMC13SSPF	Grey	10
GMCS13SSPF	Silver Grey	10

## 1 3A double-pole switched with neon &amp; flex outlet



GMC13SSPNF

Product code	Description	Pack qty
GMC13SSPNF	Grey	10
GMCS13SSPNF	Silver Grey	10

## Double-pole 30mA RCD protected - passive control



GMCPRCDFCU

Product code	Description	Pack qty
GMCPRCDFCU	Grey	1

- **Standard of compliance:**  
BS 1363
- **Mounting box:**  
40mm deep (back box supplied)
- **Plate dimensions:**  
79 x 79 x 42mm
- **Technical notes:**  
Active control consists of an electronic latch, which will require resetting in the event of a loss of supply. Particularly useful for domestic use.
- Passive control - device will only trip in the event of a fault. Suitable for freezers and commercial applications.

# High current switches

## 50A 1 gang double-pole switch



GMC50S

Product code	Description	Pack qty
GMC50S	Grey	10
GMCS50S	Silver Grey	10

- **Standard of compliance:**  
BS EN 60669-1
- **Mounting box:**  
40mm deep (back box supplied)
- **Plate dimensions:**  
79 x 79 x 42mm  
(1 gang)

## 50A 1 gang double-pole switch with neon



GMC50SN

Product code	Description	Pack qty
GMC50SN	Grey	10
GMCS50SN	Silver Grey	10

139 x 79 x 42mm  
(2 gang)

## 50A 2 gang double-pole switch with neon



GMC50S2N

Product code	Description	Pack qty
GMC50S2N	Grey	5
GMCS50S2N	Silver Grey	5

# Blank plates

## 1 gang



GMCB1

Product code	Description	Pack qty
GMCB1	Grey	10
GMCSB1	Silver Grey	10

- **Standard of compliance:**  
BS EN 5733
- **Mounting box:**  
40mm deep (back box supplied)
- **Plate dimensions:**  
79 x 79 x 42mm  
(1 gang)
- 79 x 139 x 42mm (2 gang)

## 2 gang



GMCB2

Product code	Description	Pack qty
GMCB2	Grey	5
GMCSB2	Silver Grey	5

# Grid plates

## 1 gang 88 x 88mm



GUG01GMC

Product code	Description	Pack qty
GUG01GMC	Grey	1
GBG01	Grey 76 x 76 x 42mm back box with knockouts	1
GUG01GSMC	Silver Grey	1
GBGS01	Silver Grey 76 x 76 x 42mm back box with knockouts	1
GBG01P	Grey 76 x 76 x 42mm back box without knockouts	1

- **Standard of compliance:** BS 5733
- **Mounting box:** 40mm deep
- **Technical notes:** All grid plates are supplied with the appropriate number of mounting frames.

Back box needs to be ordered separately.

## 2 gang 88 x 88mm



GUG02GMC

Product code	Description	Pack qty
GUG02GMC	Grey	1
GBG01	Grey 76 x 76 x 42mm back box with knockouts	1
GUG02GSMC	Silver Grey	1
GBGS01	Silver Grey 76 x 76 x 42mm back box with knockouts	1
GBG01P	Grey 76 x 76 x 42mm back box without knockouts	1

## 3 gang 88 x 148mm



GUG03GMC

Product code	Description	Pack qty
GUG03GMC	Grey	1
GBG02	Grey 7136 x 76 x 42mm back box with knockouts	1
GUG03GSMC	Silver Grey	1
GBGS02	Silver Grey 136 x 76 x 42mm back box with knockouts	1
GBG02P	Grey 76 x 76 x 42mm back box without knockouts	1

## 4 gang 88 x 148mm



GUG04GMC

Product code	Description	Pack qty
GUG04GMC	Grey	1
GBG02	Grey 7136 x 76 x 42mm back box with knockouts	1
GUG01GSMC	Silver Grey	1
GBGS02	Silver Grey 136 x 76 x 42mm back box with knockouts	1
GBG02P	Grey 76 x 76 x 42mm back box without knockouts	1

## 6 gang 156 x 156mm



GUG06GMC

Product code	Description	Pack qty
GUG06GMC	Grey	1
GBG03	Grey 136 x 136 x 42mm back box with knockouts	1
GUG06GSMC	Silver Grey	1
GBGS03	Silver Grey 136 x 136 x 42mm back box with knockouts	1

## 8 gang 156 x 156mm



GUG08GMC

Product code	Description	Pack qty
GUG08GMC	Grey	1
GBG03	Grey 136 x 136 x 42mm back box with knockouts	1
GUG08GSMC	Silver Grey	1
GBGS03	Silver Grey 136 x 136 x 42mm back box with knockouts	1

## Grid plates continued

### 9 gang 216 x 156mm



GUG09GMC

Product code	Description	Pack qty
GUG09GMC	Grey	1
GBG04S	Grey 202 x 136 x 42mm back box	1
GUG09GSMC	Silver Grey	1
GBGS04S	Silver Grey 202 x 136 x 42mm back box	1

- **Standard of compliance:**  
BS 5733
- **Mounting box:**  
40mm deep
- **Technical notes:**  
All grid plates are supplied with the appropriate number of mounting frames.

### 12 gang 216 x 156mm



GUG12GMC

Product code	Description	Pack qty
GUG12GMC	Grey	1
GBG04S	Grey 202 x 136 x 42mm back box	1
GUG12GSMC	Silver Grey	1
GBGS04S	Silver Grey 202 x 136 x 42mm back box	1

Back box needs to be ordered separately.

### 18 gang 398 x 156mm



GUG18GMC

Product code	Description	Pack qty
GUG18GMC	Grey	1
GBG06S	Grey 334 x 136 x 42mm back box	1
GUG18GSMC	Silver Grey	1
GBGS06S	Silver Grey 334 x 136 x 42mm back box	1

### 24 gang 398 x 156mm



GUG24GMC

Product code	Description	Pack qty
GUG24GMC	Grey	1
GBG06S	Grey 334 x 136 x 42mm back box	1
GUG24GSMC	Silver Grey	1
GBGS06S	Silver Grey 334 x 136 x 42mm back box	1

# White moulded grid modules

## Switch modules



Switch modules



GUG102W

Product code	Description	Pack qty
GUG101W	10AX 1 way	1
GUG102W	10AX 2 way	1
GUG10IW	10AX intermediate	1
GUG201W	20AX 1 way	1
GUG202W	20AX 2 way	1
GUG20DPW	20AX DP	1

- **Standard of compliance:**  
BS EN 60669-1  
(switch modules)  
BS 5733  
(indicator modules)

## 20AX double-pole printed switch modules



GUG20DPMWW



GUG20DPHTW



GUG20DPHOW

Product code	Description	Pack qty
GUG20DPMWW	20AX double-pole printed microwave	1
GUG20DPCHW	20AX double-pole printed cooker hood	1
GUG20DPDWW	20AX double-pole printed dishwasher	1
GUG20DPFZW	20AX double-pole printed freezer	1
GUG20DPMMW	20AX double-pole printed washing machine	1
GUG20DPTDW	20AX double-pole printed tumble dryer	1
GUG20DPHTW	20AX double-pole printed heater	1
GUG20DPWDYW	20AX double-pole printed washer dryer	1
GUG20DPOVW	20AX double-pole printed oven	1
GUG20DPBOW	20AX double-pole printed boiler	1
GUG20DPWDW	20AX double-pole printed waste disposal	1
GUG20DPEFW	20AX double-pole printed extractor fan	1
GUG20DPFAW	20AX double-pole printed fan	1
GUG20DPFFZW	20AX double-pole printed fridge freezer	1

## Retractive switch modules

GUG202OCW,  
GUG102RW,  
GUG2020W

Product code	Description	Pack qty
GUG202OCW	6AX 2 way & centre off	1
GUG102RW	10AX 2 way	1
GUG2020W	20AX 2 way on & off	1

## Blank & indicator modules



GUGBW



GUGINDWG



GUGINDWO

Product code	Description	Pack qty
GUGBW	Blank	1
GUGINDWG	Green indicator	1
GUGINDWR	Red indicator	1
GUGINDWO	Orange indicator	1

# White painted metal grid modules

## Key switch modules



GUG20DPKWPW &amp; GUG202KWPW



GUG202KELWPW

Product code	Description	Pack qty
GUG20DPKWPW	20AX DP	1
GUG20DPKELWPW	20AX DP printed TEST EMG LTG	1
GUG202KWPW	20AX 2 way	1

- **Standard of compliance:**  
BS EN 60669-1  
(key switches)  
BS EN 41003  
BS EN 3041

## Communication modules



GUGTELMWPW &amp; GUGTELSWPW



GUGRJ45WPW



GUGCOWPW

Product code	Description	Pack qty
GUGTELMWPW	BT master	1
GUGTELSWPW	BT secondary	1
GUGRJ11WPW	RJ11	1
GUGRJ45WPW	RJ45 CAT5e	1
GUGCOWPW	TV/FM coaxial	1
GUGSATWPW	Satellite	1

## Fused connection unit & flex outlet



GUG13FCUWPW



GUG16COWPW

Product code	Description	Pack qty
GUG13FCUWPW	13A fused connection unit	1
GUG16COWPW	Flex outlet (10mm diameter)	1





T2 CEILING



# T2 Ceiling Range

The highly successful T2 range of ceiling accessories offers superb quality and easy to install technical specification that has established this design as a firm favourite.



Fully coordinated, incorporating a large footprint for easy installation

Raised mounting feet to assist installation on uneven surfaces

Ample wiring space with four knockouts

Clear terminals for easy visibility and installation

## Specification Highlights



Batten holders and ceiling roses share a common base assembly with 50.8mm fixing centres



Pendant lamp holder has integral cord grip to prevent cable pull on terminals



Full complementary accessories including dry lining and conduit boxes

# Batten lamp holders

## Pre-wired straight



GBAT

Product code	Description	Pack qty
GBAT	Black base	10
GBATC	Clear base	10

- **Standard of compliance:**  
BS EN 61184

- **Technical notes:**  
Large capacity earth terminals.

Ample wiring space with four knockouts.

Clear terminals for easy visibility and installation.

## Pre-wired angled



GABAT

Product code	Description	Pack qty
GABAT	Black base	10
GABATC	Clear base	10

## 3 terminal straight



GEBAT

Product code	Description	Pack qty
GEBAT	Black base	10

# Pendant sets

## Pre-wired 6 inch urea



GPEND62

Product code	Description	Pack qty
GPEND62	Black base	10
GPEND6C2	Clear base	10

- **Standard of compliance:**  
BS EN 60598-2-1  
BS EN 61184

- **Technical notes:**  
CFL lamps not supplied with energy saving pendants.

High heat resistance to BS EN 61184:1995.

## Pre-wired 9 inch urea



GPEND92

Product code	Description	Pack qty
GPEND92	Black base	10
GPEND9C2	Clear base	10

## Energy saving 6 inch



GESPEND613

Product code	Description	Pack qty
GESPEND613	13W	1
GESPEND618	18W	1

## Ceiling roses

### Urea



GRO

Product code	Description	Pack qty
GRO	Black base	10
GROC	Clear base	10

- **Standard of compliance:** BS EN 61184
- **Technical notes:** Urea base centres are 50.8mm.

### Polycarbonate



E93WE

Product code	Description	Pack qty
E93WE	Ceiling rose	1

## Lamp holders

### With intergral cord grip



GLHC

Product code	Description	Pack qty
GLHC	With intergral cord grip	20

- **Standard of compliance:** BS EN 61184

### Polycarbonate short skirt



E501SSWE

Product code	Description	Pack qty
E501SSWE	Polycarbonate short skirt	1

## Ceiling switches

### 6AX



GSWPULL6

Product code	Description	Pack qty
GSWPULL6	1 way	10
GSWPULL62	2 way	10

- **Standard of compliance:** BS EN 60669-1
- **Technical notes:** All switches supplied with 1.5m white nylon cord.

### 50A 1 way



GSWPULL50

Product code	Description	Pack qty
GSWPULL50	1 way	10
GSWPULL50N	2 way	10

6AX switches fully rated for fluorescent and inductive loads.

50A switch suitable for use as an isolator switch.

# Junction boxes

5A 4 terminal selective entry 4 x 1.5mm



GJB5ABR

Product code	Description	Pack qty
GJB5A	White	10
GJB5ABR	Brown	10

20A 4 terminal selective entry 3 x 2.5mm



GJB20A

Product code	Description	Pack qty
GJB20A	White	10
GJB20ABR	Brown	10

20A 4 terminal non-selective entry 3 x 2.5mm



GJBN20ABR

Product code	Description	Pack qty
GJBN20A	White	10
GJBN20ABR	Brown	10

20A 6 terminal selective entry x 2.5mm



GJB620A

Product code	Description	Pack qty
GJB620A	White	10
GJB620ABR	Brown	10

30A 3 terminal selective entry x 4mm



GJB30ABR

Product code	Description	Pack qty
GJB30A	White	10
GJB30ABR	Brown	10

Compact 20A 4 terminal non-selective entry 59mm ø



GJBN20AS

Product code	Description	Pack qty
GJBN20AS	White	10
GJBN20ASBR	Brown	10

- **Standard of compliance:**  
BS EN 60670-22
- **Technical notes:**  
Dimensions: 5A & 20A - ø74mm, 30mm - ø85mm.
- **Terminal capacity:**  
5A 4 x 1.5mm<sup>2</sup>  
20A 2 x 2.5mm<sup>2</sup>  
30A 4 x 4mm<sup>2</sup>.

# Junction boxes

## Circular 50.8mm fixing centre



CRB2W

Product code	Description	Pack qty
CRB2W	Circular 50.8mm fixing centre	10

- **Standard of compliance:** BS 5733
- **Technical notes:** Circular boxes suitable for pendant drops & smoke alarms.
- **Circular diameter:** 67mm
- **Square:** min. & max. thickness 2-17mm.

## Square 34mm deep



GDL1

Product code	Description	Pack qty
GDL1	1 gang	10
GDL1	2 gang	10

# Flush galvanised steel boxes

## 16mm deep



SB161

Product code	Description	Pack qty
SB161	1 gang	20

- **Standard of compliance:** BS 4662
- **Technical notes:** Supplied with earth terminal and screw.

## 25mm deep

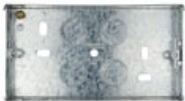

SB252

Product code	Description	Pack qty
SB251	1 gang	10
SB252	2 gang	10

- Supplied with fixed and adjustable lugs.

Fitted with selection of 20mm knockouts in sides and back.

## 35mm deep



SB351

Product code	Description	Pack qty
SB351	1 gang	10
SB352	2 gang	5

## 47mm deep



SB472

Product code	Description	Pack qty
SB471	1 gang	10
SB472	2 gang	4

## Plugs & adaptors

### Round pin plug



TOP5AR

Product code	Description	Pack qty
TOP2AR	2A	20
TOP5AR	5A	20
TOP15AR	15A	20

- **Standard of compliance:**  
BS 1363 (13A plugs)  
BS 546 (round pin plugs)

### Fused plug top



400104

Product code	Description	Pack qty
TOP133A	3A white	20
TOP13A	13A white	20
400102	13A white	20
400104	13A heavy duty orange	1

### Adaptors



ADAPT3WF

Product code	Description	Pack qty
ADAPT2W	2 way unfused	10
ADAPT3WF	3 way fused	10

### BS 1362 fuses



400114

Product code	Description	Pack qty
400112	3A	4
400113	5A	4
400114	13A	4

## Plain IP56 moulded enclosures

### 6 entries



GE115P

Product code	Description	Pack qty
GE115P	100 x 100 x 50mm	1
GE125P	120 x 80 x 50mm	1

- **Technical notes:**  
GE321P & GE381P  
- Hinged lids.

GE84S & GE884S  
- IP44 rating.

### 10 entries

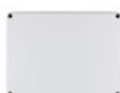

GE197P

Product code	Description	Pack qty
GE157P	150 x 110 x 70mm	1
GE197P	190 x 140 x 70mm	1

### 12 entries



GE249P

Product code	Description	Pack qty
GE249P	240 x 190 x 90mm	1
GE321P	300 x 220 x 120mm	1
GE381P	380 x 300 x 120mm	1



# Stepped IP56 moulded enclosures

## 4 entries



GE84S

Product code	Description	Pack qty
GE84S	80 x 40mm	1

- **Technical notes:**  
GE321P & GE381P  
- Hinged lids.

GE84S & GE884S  
- IP44 rating.

## 6 entries



GE115S

Product code	Description	Pack qty
GE884S	80 x 80 x 40mm	1
GE115S	100 x 100 x 50mm	1

E-SERIES



# E-Series Polycarbonate

The E-Series range of wiring accessories is made of high impact resistant polycarbonate components. The construction of these switches and sockets is tough, resilient, built to take hard knocks and guaranteed to provide exceptional product life.

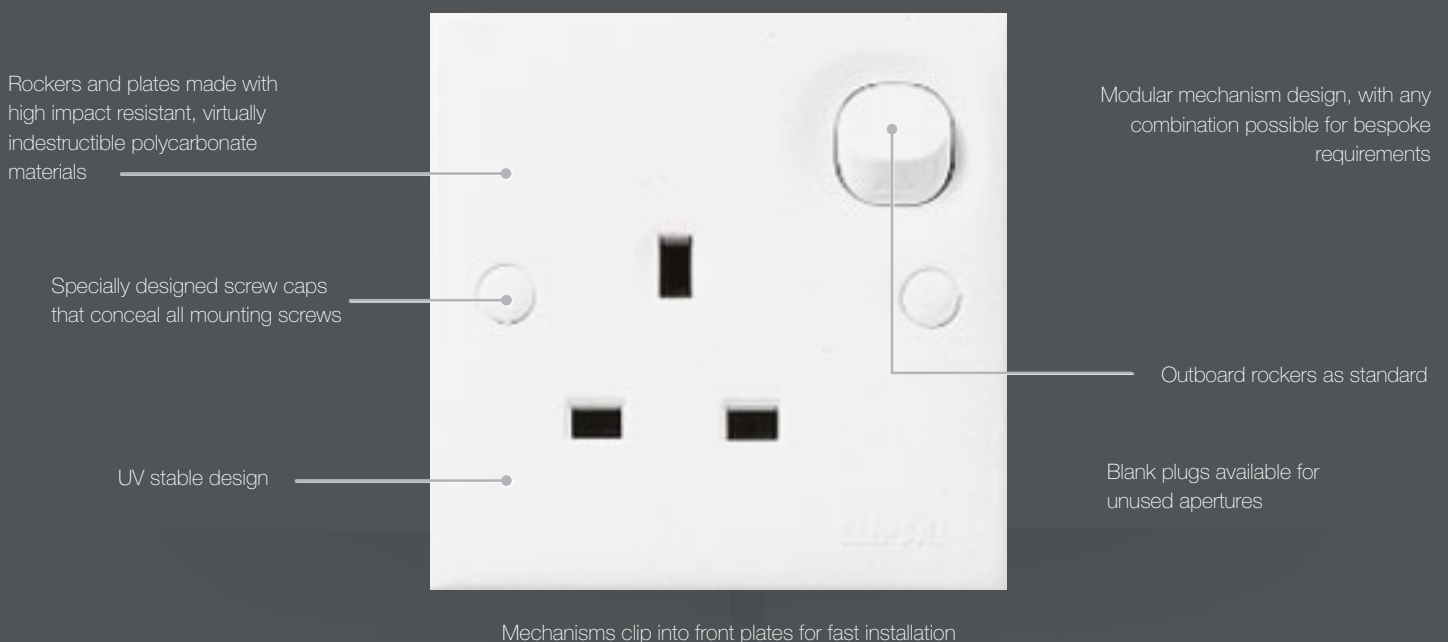

## Converta Socket Outlets



Converta wiring accessories are an ideal retrofit component for existing installations. They allow single to double, or double to triple conversion of standard flush mounted wiring accessories without the need for additional cabling or chasing.

- Private or public sector, domestic or commercial applications
- Allows 2 gang socket to fit on 1 gang box or 3 gang socket to fit on 2 gang box
- Quick and easy replacement
- Saves time and money
- Reduces the need for redecorating
- Virtually indestructible polycarbonate front plate
- Dual earth for easy installation

## True Modular Design

For true ordering flexibility, the E-Series incorporates a modular mechanism design and multi-gang capability. Simply choose between a wide selection of mechanisms that clip easily and securely into E-Series front plates for a hassle-free and tailored solution.

# Socket outlets

## 13A unswitched



E426WE

Product code	Description	Pack qty
E426WE	13A unswitched	1

## 13A 1 gang switched



E15WE &amp; E15DWE

Product code	Description	Pack qty
E15WE	Single-pole	1
E15DWE	Double-pole	1

## 13A 2 gang with outboard rockers



E25WE, E25DWE

Product code	Description	Pack qty
E25WE	Single-pole	1
E25NWE	Single-pole with neon	1
E25DWE	Double-pole	1

## 2 gang with surge protection



E25SFWE

Product code	Description	Pack qty
E25SFWE	2 gang	1

## 2 gang clean earth with surge protection



E25CESFNWE

Product code	Description	Pack qty
E25CESFNWE	2 gang clean with neon	1

## 1 to 2 gang converta



E251WE, E251BP

Product code	Description	Pack qty
E251WE	1 to 2 gang converta	1
E251BP	1 to 2 gang converta - display packaged	1

## 2 to 3 gang converta

E25DF32WE,  
E25DF32BP

Product code	Description	Pack qty
E25DF32WE	2 to 3 gang converta	1
E25DF32BP	2 to 3 gang converta - display packaged	1

- **Standard of compliance:**  
BS 1363 (13A)
- **Mounting box:**  
25mm deep
- **Fixing screws:**  
M3.5 x 30mm
- **Plate dimensions:**  
87 x 87mm (1 gang)  
87 x 149mm (2 gang)
- **Technical notes:**  
High integrity earthing  
as standard.

# IP54 switch

1 gang switch



E31WP23SAWE

Product code	Description	Pack qty
E31WP23SAWE	2 way	1

- **Standard of compliance:**  
BS 5733

# Time delay switch

10A 1 gang pneumatic



E319WE

Product code	Description	Pack qty
E319WE	1 gang	1

- **Standard of compliance:**  
IEC 60669-2-1
- **Technical notes:**  
Adjustable up to 20 minutes.

Designed for use in corridors and staircases.

# Plate switches

10A 1 gang



E311SAWE &  
E312SAWE

Product code	Description	Pack qty
E311SAWE	1 way	1
E312SAWE	2 way	1
E311AWE	Intermediate	1

- **Standard of compliance:**  
BS EN 60669-1
- **Mounting box:**  
16mm deep (1-2 gang)  
25mm deep (3-4 gang)
- **Fixing screws:**  
M3.5 x 18mm
- **Plate dimensions:**  
87 x 87mm (1 gang)

10A 2 gang



E322SAWE

Product code	Description	Pack qty
E322SAWE	2 way	1

10A 3 gang



E332SAWE

Product code	Description	Pack qty
E332SAWE	2 way	1

10AX 4 gang



E342SAWE

Product code	Description	Pack qty
E342SAWE	2 way	1

## Plate switches continued

### 10A 1 gang architrave



30WE

Product code	Description	Pack qty
30WE	2 way	1

- **Standard of compliance:** BS EN 60669-1
- **Mounting box:** 16mm deep (1-2 gang)
- **Fixing screws:** M3.5 x 18mm
- **Plate dimensions:** 33 x 87mm (architrave)

## Control switches

### 20AX DP 1 gang switched



E32D20NGEWE

Product code	Description	Pack qty
E32D20NGEWE	With neon	1

- **Standard of compliance:** BS EN 60669-1
- **Mounting box:** 25mm deep
- **Fixing screws:** M3.5 x 30mm
- **Plate dimensions:** 87 x 87mm
- **Technical notes:** Bottom cable outlet.

## Fused connection units

### 1 3A unswitched



E30FSGWE

Product code	Description	Pack qty
E30FSGWE	13A unswitched	1

- **Standard of compliance:** BS EN 60669-1

### 1 3A switched with neon



E31DFSGNWE

Product code	Description	Pack qty
E31DFSGNWE	13A switched with neon	1

- **Mounting box:** 25mm deep
- **Fixing screws:** M3.5 x 30mm
- **Plate dimensions:** 87 x 87mm
- **Technical notes:** Bottom cable outlet.

## High current switches

### 45A DP switch with neon



ED45NWE

Product code	Description	Pack qty
ED45NWE	45A DP switch with neon	1

- **Standard of compliance:** BS EN 60669-1
- **Mounting box:** 40mm deep
- **Fixing screws:** M3.5 x 30mm
- **Plate dimensions:** 87 x 87mm (1 gang)

# Shaver sockets

115/230V dual voltage



E727WE

Product code	Description	Pack qty
E727WE	115/230V dual voltage	1

- **Standard of compliance:**  
BS EN 61558-2-5
- **Mounting box:**  
40mm deep
- **Fixing screws:**  
M3.5 x 30mm
- **Plate dimensions:**  
149 x 87mm

# Telephone outlets

Telephone



E34061MWE

Product code	Description	Pack qty
E34061MWE	BT master	1
ET01E	US style	1

- **Standard of compliance:**  
BS EN 41003
- **Mounting box:**  
25mm deep
- **Fixing screws:**  
M3.5 x 30mm
- **Plate dimensions:**  
87 x 87mm (1 gang)

# Blank plates & accessories

Blank plates



E31XWE

Product code	Description	Pack qty
E31XWE	1 gang	1
E312XWE	2 gang	1

- **Standard of compliance:**  
BS 5733
- **Fixing screws:**  
M3.5 x 30mm
- **Plate dimensions:**  
87 x 87mm (1 gang)  
87 x 149mm (2 gang)

Accessories



31J

Product code	Description	Pack qty
31J	Securing screws for mechanisms	1
9WE	Screw cap covers	1
30PWE	Moulded removable plugs - plain	1

# Grid plates

## 1 to 3 gang



Product code	Description	Pack qty
E31WE	1 gang	1
E32WE	2 gang	1
E33WE	3 gang	1

• **Standard of compliance:**  
BS 5733

## 4 to 6 gang



Product code	Description	Pack qty
E34WE	4 gang	1
E35WE	5 gang	1
ET36WE	6 gang	1

## 2 gang architrave



Product code	Description	Pack qty
32WE	2 gang	1

## IP54 1 gang plate

Product code	Description	Pack qty
E31WPWE	IP54 1 gang plate	1



# Switch grid mechanisms

## 10A



301SMWE

39MWE

Product code	Description	Pack qty
301SMWE	10A 1 way 2 terminal	1
30MWE	10A 2 way	1
30MIWE	10A intermediate	1

- **Standard of compliance:**  
BS EN 60669-1

## 20A



30MD20WE

30TKMWE

Product code	Description	Pack qty
30USMWE	20A 16AX universal	1
30MD20WE	20A double-pole	1
30TKMWE	20A 2 way toggle key actuated	1

## 35A



30M35WE

Product code	Description	Pack qty
30M35WE	35A 2 way 4 terminal	1

## 115A 440V bell push



30MBPWE

30MBPNWE



30MBPRWE

Product code	Description	Pack qty
30MBPWE	115A 440V bell push	1
30MBPNWE	115A 440V bell push with neon	1
30MBPRWE	115A 440V bell push printed press	1

# Dimmer grid mechanisms

## 400VA

32E450LMWE,  
32E450TMWE

Product code	Description	Pack qty
32E450LMWE	Leading edge	1
32E450TMWE	Trailing edge	1

# Indicators, fuse carrier & surge filter grid mechanisms

## 250V neon indicators



30NRD

30NGR

Product code	Description	Pack qty
30NRD	250V neon indicators red	1
30NGR	250V neon indicators green	1

- **Standard of compliance:**  
BS 5733  
BS 5518  
BS 1363

## 1 3A fuse carrier



30FSWE

Product code	Description	Pack qty
30FSWE	13A fuse carrier	1

## Surge filter



30SFMOP

Product code	Description	Pack qty
30SFMOP	Surge filter	1

# TV & data grid mechanisms

## Data outlet with shutter



30RJ45SMA5SHWE

Product code	Description	Pack qty
30RJ45SMA5SHWE	CAT5	1
30RJ45SMA6SHWE	CAT6	1

## Data outlet with shutter



30TV75MSWE



30PFMWE

Product code	Description	Pack qty
30TV75MSWE	75 ohm crimp type	1
30PFMWE	F type satellite	1

# Surface pattresses

## 1 gang

Product code	Description	Pack qty
E238WE	35mm	1

- **Standard of compliance:**  
BS 5733  
BS 5518  
BS 1363

## 2 gang



ET238WE

Product code	Description	Pack qty
ET238WE	35mm	1

## Architrave



701WE

Product code	Description	Pack qty
701WE	1 gang	1

# Flush galvanised steel boxes

## 16mm deep



SB161

Product code	Description	Pack qty
SB161	1 gang	20

- **Standard of compliance:**  
BS 4662

- **Technical notes:**  
Supplied with earth terminal and screw.

## 25mm deep

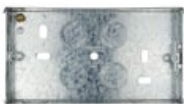

SB252

Product code	Description	Pack qty
SB251	1 gang	10
SB252	2 gang	10

Supplied with fixed and adjustable lugs.

Fitted with selection of 20mm knockouts in sides and back.

## 35mm deep



SB351

Product code	Description	Pack qty
SB351	1 gang	10
SB352	2 gang	5

## 47mm deep



SB472

Product code	Description	Pack qty
SB471	1 gang	10
SB472	2 gang	4

WEATHERPROOF



# Weatherproof solutions

Our weatherproof range offers tough, durable options for outdoor applications or more arduous environments. Socket outlets are IP66 or IP55 rated for even greater weather resistance.



## IP66

The IP66 range of weatherproof accessories offers the greatest amount of weatherproof protection on the market, with built-in features to safeguard users in the harshest of environments.

- **Solid Protection:** Completely protected against dust, the maximum rating for protection against solids.
- **Liquid Protection:** Protected against jets of water of similar force to heavy seas.



## IP55

For general weatherproof protection, the IP55 range of switches and sockets can be comfortably operated through a protective membrane, thus maintaining its full IP rating.

- **Solid Protection:** Protected against quantities of dust that could interfere with satisfactory operation.
- **Liquid Protection:** Protected against jets of water from all directions



## KAVACHA

With its unique polycarbonate construction, Kavacha IP56 Sockets provide the ideal domestic weatherproof and waterproof solution for full-time protection in areas around the home that are susceptible to water, rain and moisture.

Offering maximum protection, the sturdy range of Kavacha IP66 switches are ideal for outdoor areas that are susceptible to heavy blows, long time exposure to the elements and risk being splashed by chemicals.

# IP55 Range

For general weatherproof protection against dust and liquids, the IP55 range of switches and sockets offers an effective solution for both indoor and outdoor environments when the maximum IP66 rating is not required.

The weatherproof membrane is Phthalate free, UV stabilised and mould and algae resistant, to ensure long outdoor life without splitting or discolouring.

Switches can be operated through membrane, thereby maintaining full IP rating

IP55 switches supplied complete in 1, 2 or 3 gang configurations using 25mm modules

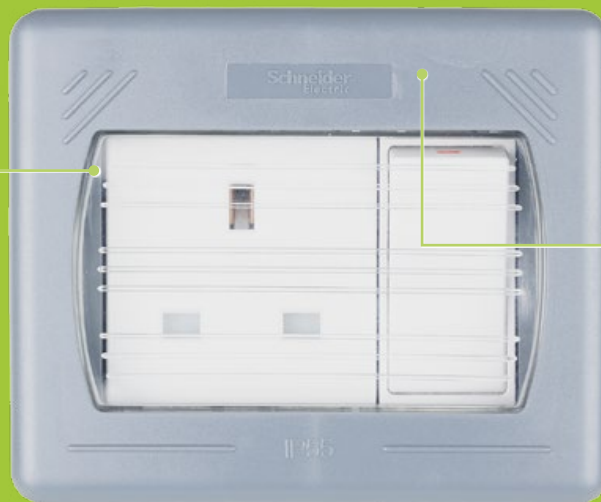

All modules are independently type tested, with the enclosures giving a degree of ingress protection of IP55 – protection against quantities of dust that could interfere with satisfactory operation or powerful jets of water from all directions

Enclosures are fitted with 20mm knockouts to accept all standard UK conduit fittings and include a unique drill start feature for use with 25mm conduit fittings. The installer simply uses a standard 25mm hole saw in this drill start to ensure the correct spacing between conduit and wall.

Offered in two distinctive finish and design configurations

# IP66 Range

Offering the maximum levels of endurance and protection, the IP66 weatherproof range of sockets will perform in the most arduous weather conditions.

The smooth, curved design also delivers on aesthetic appeal whilst providing a high performance application.

IP66 for maximum weatherproof protection against any particles of dust and jets of water of similar force to heavy seas whilst in use.

Manufactured from tough impact resistant thermoplastic which provides strength and durability

Protective jell seal ensures maximum safety whilst in use



Standard knockouts for 20mm conduit entry with additional cut-out facility to convert to 25mm conduit entry

IP66 sockets accept standard 13A plugs including moulded on plugs

Smooth, curved aesthetic design

## Specification Highlights



**Passive and Active RCD protected 2-gang socket outlet ensure essential personal protection.**

**Passive Latching:** Designed for food freezers or garden water feature pumps, ensuring that contacts will stay closed during loss of power so that RCD does not need re-setting when the circuit is restored

**Active / non-latching:** Designed for lawnmowers or power tools, the RCD will trip on loss of power and requires manual resetting when the circuit is to be re-energised.



Choose from a flexible selection of IP66 enclosures and modules to meet your project requirements

# Socket outlets

## 1 3A 1 gang unswitched



GWP3050

Product code	Description	Pack qty
GWPIU3050	13A 1 gang unswitched - IP66	1
GWP3050	13A 1 gang unswitched - IP55	1
E551US	13A 1 gang unswitched - IP55	1

## 1 3A 2 gang unswitched



GWPIU3060

Product code	Description	Pack qty
GWPIU3060	13A 2 gang unswitched - IP66	1
GWP3060	13A 2 gang unswitched - IP55	1

## 1 3A 1 gang switched



GWP3010



E551SS

Product code	Description	Pack qty
GWP3010	13A 1 gang switched - IP55	1
E551SS	13A 1 gang switched - IP55	1

## 1 3A 2 gang switched



GWPIU3020



GWP3020

Product code	Description	Pack qty
GWPIU3020	13A 2 gang switched - IP66	1
GWP3020	13A 2 gang switched - IP55	1

## 2 gang DP 30mA RCD protected



GWPIU3020R

Product code	Description	Pack qty
GWPIU3020R	Active control - IP66	1
GWPIU3020RP	Passive control - IP66	1

- **Standard of compliance:**  
BS 1363 (13A)  
BS 7288 (RCDs)
- **Mounting box:**  
40mm deep (back box supplied)
- **Technical notes:**  
Active control consists of an electronic latch, which will require resetting in the event of a loss of supply. Particularly useful for domestic use.

Passive control - device will only trip in the event of a fault. Suitable for freezers and commercial applications.

IP rating maintained for IP66 devices whilst in use. IP55 sockets are rated at IP4X whilst in use.



# Plate switches

## 10AX 1 gang 2 way



GWP1612

Product code	Description	Pack qty
GWP1612	10AX 1 gang 2 way - IP55	1

- **Standard of compliance:**  
BS EN 60669-1
- **Mounting box:**  
40mm deep (back box supplied)

## 10AX 1 gang intermediate



GWP1614

Product code	Description	Pack qty
GWP1614	10AX 1 gang intermediate - IP55	1

## 10AX 1 gang retractive



E55PB

Product code	Description	Pack qty
E55PB	10AX 1 gang retractive - IP55	1

## 10AX 2 gang 2 way



GWP1622



E5522S

Product code	Description	Pack qty
GWP1622	10AX 2 gang 2 way - IP55	1
E5522S	10AX 2 gang 2 way - IP55	1

## 10AX 3 gang 2 way



GWP1632

Product code	Description	Pack qty
GWP1632	10AX 3 gang 2 way - IP55	1

# Control switches

## 20AX DP 1 gang switch



GWP2010

Product code	Description	Pack qty
GWP2010	20AX DP 1 gang switch - IP55	1

- **Standard of compliance:**  
BS EN 60669-1
- **Mounting box:**  
40mm deep (back box supplied)

## 20AX DP 1 gang switch with neon



GWP2011

Product code	Description	Pack qty
GWP2011	20AX DP 1 gang switch with neon - IP55	1

## Enclosure & modules

### Enclosure



GWP9000

Product code	Description	Pack qty
GWP9000	Enclosure	1

- **Standard of compliance:**  
BS 5733  
BS EN 60670

- **Mounting box:**  
40mm deep (back box supplied)

### Seal kit - 2 x silicone seals & 2 x mounting brackets



GWPIUKIT

Product code	Description	Pack qty
GWPIUKIT	Seal kit - 2 x silicone seals & 2 x mounting brackets	1

### White 20AX switch modules



Product code	Description	Pack qty
GRL2020PW	2 way & off switch module	1
GRL202KPW	2 way key	1
GRL20DPNPW	Double-pole with neon	1
GRLDPKPW	Double-pole key	1

### White fuse carrier, indicator & flex modules



Product code	Description	Pack qty
GRL13FCUPW	13A single-pole fuse carrier	1
GRLINDRPW	240V red indicator	1
GRLCOPW	10mm ø cord outlet	1

## Connection box & grommets

### Connection box



E55CB

Product code	Description	Pack qty
E55CB	Connection box	1

- **Standard of compliance:**  
BS EN 60669-1

- **Mounting box:**  
40mm deep (back box supplied)

### Grommets



E55GP

Product code	Description	Pack qty
E55GP	Grommets	1



# Full time protection around the home

This sturdy range of switches and sockets are for outdoor areas that are susceptible to heavy blows, long time exposure to sunlight and where there is a risk of being splashed by chemicals.

Balconies, swimming pools, exterior walls and gardens will all be much safer from exposed electricity with Kavacha. Kavacha protects you and your family outdoors in five important ways. It guards against water sprayed from a hose. It guards against rain or water, is dust proof, impact resistant, UV resistant and also chemical resistant.



KAVACHA



# Socket outlets

IP56 13A 1 gang unswitched



CSO313

Product code	Description	Pack qty
CSO313	IP56 13A 1 gang unswitched	1

IP56 13A 2 gang unswitched



CSO3132

Product code	Description	Pack qty
CSO3132	IP56 13A 2 gang unswitched	1

IP56 13A 1 gang switched



CSC313

Product code	Description	Pack qty
CSC313	IP56 13A 1 gang switched	1

- **Standard of compliance:**  
BS 1363  
BS 1363-2  
IEC 60529  
IEC 60669-1

- **Technical notes:**  
Active control consists of an electronic latch, which will require resetting in the event of a loss of supply. Particularly useful for domestic use.

Passive control - device will only trip in the event of a fault. Suitable for freezers and commercial applications.

IP rating maintained for IP66 devices whilst in use. IP55 sockets are rated at IP4X whilst in use.

# Plate switches

IP66 16A 250V 1 gang 2 way



CSW120

Product code	Description	Pack qty
CSW120	IP66 16A 250V 1 gang 2 way	1

- **Standard of compliance:**  
BS EN 60669-1

- **Technical notes:**  
Single-pole switches include a looping terminal.

IP66 20A 250V 2 gang 2 way



CSW1202

Product code	Description	Pack qty
CSW1202	IP66 20A 250V 2 gang 2 way	1

IP66 20A 500V 1 gang double-pole isolator



CSW220

Product code	Description	Pack qty
CSW220	IP66 20A 500V 1 gang double-pole	1

# Triple pole control switches

20A 440V



WHB320RG

Product code	Description	Pack qty
WHB320RG	20A 440V	1

- **Technical notes:**  
32mm conduit entry each end.

35A 440V



WHB340RG

Product code	Description	Pack qty
WHB340RG	35A 440V	1

55A 440V



WHB355RG

Product code	Description	Pack qty
WHB355RG	55A 440V	1

63A 440V



WHC363RG

Product code	Description	Pack qty
WHC363RG	63A 440V	1

56 SERIES





# 56 Series industrial switchgear

Designed to satisfy customer needs, precisely engineered and carefully manufactured, the 56 Series is as versatile as your customers' requirements. Industrial switchgear, being one of the most important components of industry, has to be tough, safe, and able to take hard knocks and give reliable performance under adverse conditions.

The 56 Series satisfies these challenges with the use of durable engineering plastics. The 56 Series has been tested for protection against ingress of water and dust to international protection ratings IP56, and in many instances exceeds this level of protection.



Chemical resistant for arduous environments

56 Series products are just as acceptable alongside a public or domestic swimming pool

The aesthetic appearance of the 56 Series makes it the ideal choice for installation in commercial facilities such as television studios, shopping centres and warehouses

Quick, easy and safe wiring

Hi-impact polycarbonate materials proven and tested to operate in extreme temperatures from -40°C to +55°C

Specially formulated chemical resistance – resistant orange specifically designed for environments where harsh chemicals are used

Solvent bonding capability

Greater UV resistance

Modular design makes assembly simple

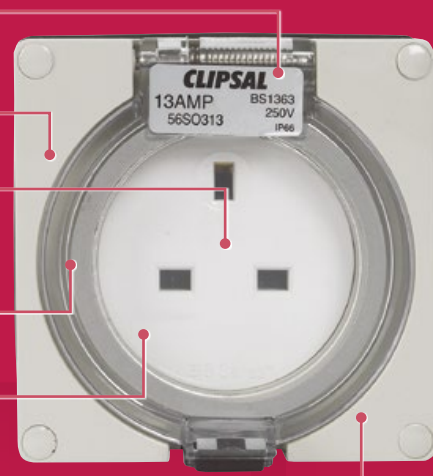

# Designed to mix and match

What suits one industry might not be the perfect match for another. That's why the 56 Series was specifically designed to mix and match. There is an extensive choice of modules available, including switches, sockets and residual current devices.

56 Series mounting enclosures range from 1 to 9 gang. This allows assemblies to be customised - from a simple switch station to a large electrical control panel.

Accessories can be ordered without the back box by choosing the product code with LE (less enclosure) towards the end.





# IP66 - Socket outlets

13A 250V 3 pin



56SO313LEGY

Product code	Description	Pack qty
56SO313GY	Grey (with enclosure)	1
56SO313LEGY	Grey (without enclosure)	1
56SO313RO	Resistant orange (with enclosure)	1

- **Standard of compliance:**  
IEC 60529  
BS 1363

16A 4h 110V

Product code	Description	Pack qty
56SO316110LEGY	Grey (without enclosure)	1

16A 6h 220/250V 3 pin

Product code	Description	Pack qty
56SO3166LEGY	Grey (without enclosure)	1

16A 6h 380/415V 4 pin

Product code	Description	Pack qty
56SO4166LEGY	Grey (without enclosure)	1

16A 6h 380/415V 5 pin



56SO5166LEGY

Product code	Description	Pack qty
56SO5166LEGY	Grey (without enclosure)	1

20A 220/250V 5 pin



56SO520LEGY

Product code	Description	Pack qty
56SO520LEGY	Grey (without enclosure)	1

32A 240V



56SO332GY

Product code	Description	Pack qty
56SO332GY	Grey (with enclosure)	1

32A 6h 220/250V 3 pin

Product code	Description	Pack qty
56SO3326LEGY	Grey (without enclosure)	1

32A 6h 380/415V 4 pin

Product code	Description	Pack qty
56SO4326LEGY	Grey (without enclosure)	1

32A 6h 380/415V 5 pin

Product code	Description	Pack qty
56SO5326LEGY	Grey (without enclosure)	1

## IP66 - Fuse units

15A 250V switched



56FCULEGY

Product code	Description	Pack qty
56FCUGY	Grey (with enclosure)	1
56FCULEGY	Grey (without enclosure)	1

- Standard of compliance: IEC 60529

## IP66 - Rotary switches

10AX 240/250V 1 way



56SW110GY

Product code	Description	Pack qty
56SW110GY	Grey (with enclosure)	1
56SW110LEGY	Grey (without enclosure)	1
56SW110LERO	Resistant orange (without enclosure)	1

- Standard of compliance: IEC 60669-1 IEC 60529

20A 250V

Product code	Description	Pack qty
56SW120LEGY	Grey (without enclosure)	1
56SW120LERO	Resistant orange (without enclosure)	1

32A 250V



56SW132LEGY

Product code	Description	Pack qty
56SW132LEGY	Grey (without enclosure)	1

## IP66 - Double-pole switch disconnectors

20A 500V



56SW220LERO

Product code	Description	Pack qty
56SW220LEGY	Grey (without enclosure)	1
56SW220LERO	Resistant orange (without enclosure)	1

• **Standard of compliance:**  
BS EN 60947-3

32A 500V



56SW232LERO

Product code	Description	Pack qty
56SW232LEGY	Grey (without enclosure)	1
56SW232LERO	Resistant orange (without enclosure)	1

## IP66 - Triple-pole switch disconnectors

10A 500V



56SW310LEGY

Product code	Description	Pack qty
56SW310LEGY	Grey (without enclosure)	1

• **Standard of compliance:**  
BS EN 60947-3

20A 500V



56SW320LEGY

Product code	Description	Pack qty
56SW320LEGY	Grey (without enclosure)	1
56SW320LERO	Resistant orange (without enclosure)	1

32A 500V



56SW332LERO

Product code	Description	Pack qty
56SW332LEGY	Grey (without enclosure)	1
56SW332LERO	Resistant orange (without enclosure)	1

50A 500V



56SW350LEGY

Product code	Description	Pack qty
56SW350LEGY	Grey (without enclosure)	1

63A 500V



56SW363LEGY

Product code	Description	Pack qty
56SW363LEGY	Grey (without enclosure)	1
56SW363LERO	Resistant orange (without enclosure)	1

# IP66 - Control switches

## 10AX 250V single sliding dolly



56SSW10LEGY

Product code	Description	Pack qty
56SSW10LEGY	Grey (without enclosure)	1

• **Standard of compliance:**  
BS EN 60947-3

## 10A 250V two way

Product code	Description	Pack qty
56SSW210LEGY	Grey (without enclosure)	1

## 15AX 250V single sliding dolly



56SSW15LEGY

Product code	Description	Pack qty
56SSW15LEGY	Grey (without enclosure)	1
56SSW15LERO	Resistant orange (without enclosure)	1

## 15A 250V two way

Product code	Description	Pack qty
56SSW215LEGY	Grey (without enclosure)	1

## 20A 500V DP changeover & reversing



56SW220COLEGY

Product code	Description	Pack qty
56SW220COLEGY	Grey (without enclosure)	1

## 20A 440V 4 pole

Product code	Description	Pack qty
56SW420LERO	Resistant orange (without enclosure)	1
56SW420LEGY	Grey (without enclosure)	1

## Emergency stop push



56PBS1LEGY

Product code	Description	Pack qty
56PBS1LEGY	Grey (without enclosure)	1

## IP66 - Plugs

10A 250V 3 pin



56P310GY

Product code	Description	Pack qty
56P310GY	Grey	1

• **Standard of compliance:**  
IEC 60529  
BS 1363  
BS 546

13A 250V 3 pin



56P313GY

Product code	Description	Pack qty
56P313GY	Grey	1
56P313RO	Resistant orange	1
56P313EO	Electric orange	1

15A 250V 3 pin



56P315GY

Product code	Description	Pack qty
56P315GY	Grey	1

## Moulded covers

1 gang lid for 2 x E-Series mechanisms

Product code	Description	Pack qty
5632LEGY	Grey	1
5632LERO	Resistant Orange	1

• **Standard of compliance:**  
IEC 60529  
BS 5733

2 gang lid for 4 module device



56CB4GY

Product code	Description	Pack qty
56CB4GY	Grey	1

2 gang lid for 4 module device with neons

Product code	Description	Pack qty
56CB4NGY	Grey	1
56CB4NRO	Resistant orange	1

1 gang blank lid



56L1GY

Product code	Description	Pack qty
56L1GY	Grey	1



2 gang blank lid



56L2GY

Product code	Description	Pack qty
56L2GY	Grey	1

## Surface mounted enclosure

1 gang 101 x 101 x 63mm



56E1RO

Product code	Description	Pack qty
56E1GY	Grey	1
56E1RO	Resistant orange	1

- **Standard of compliance:**  
BS EN 60947-3

1 gang shallow 101 x 101 x 38mm



56ES1GY

Product code	Description	Pack qty
56ES1GY	Grey	1

2 gang 198 x 101 x 63mm



56E2RO

Product code	Description	Pack qty
56E2GY	Grey	1
56E2RO	Resistant orange	1

2 gang shallow 198 x 101 x 38mm



56ES2GY

Product code	Description	Pack qty
56ES2RO	Grey	1
56ES2GY	Resistant orange	1

2 gang deep 198 x 101 x 100mm



56ED2GY

Product code	Description	Pack qty
56ED2GY	Grey	1

3 gang 294 x 101 x 63mm

Product code	Description	Pack qty
56E3GY	Grey	1
56E3RO	Resistant orange	1

## Surface mounted enclosure continued

4 gang 198 x 198 x 63mm



56E4GY

Product code	Description	Pack qty
56E4GY	Grey	1
56E4RO	Resistant orange	1

• **Standard of compliance:**  
BS EN 60947-3

4 gang vertical 391 x 101 x 63mm



56E4VHGY

Product code	Description	Pack qty
56E4VHGY	Grey	1

6 gang 294 x 198 x 63mm

Product code	Description	Pack qty
56P310GY	Grey	1
56P310RO	Resistant Orange	1

8 gang 391 x 198 x 63mm



56E8GY

Product code	Description	Pack qty
56E6GY	Grey	1
56E6RO	Resistant orange	1

9 gang 294 x 294 x 63mm



56E9GY

Product code	Description	Pack qty
56E9GY	Grey	1

## Flush mounted surrounds

1 gang



56FA1GY

Product code	Description	Pack qty
56FA1GY	Grey	1

2 gang



56FA2GY

Product code	Description	Pack qty
56FA2GY	Grey	1

3 gang



56FA3GY

Product code	Description	Pack qty
56FA3GY	Grey	1

4 gang



56FA4GY

Product code	Description	Pack qty
56FA4GY	Grey	1

## Combination devices

1 3A 250V 2 pin socket &amp; switch



56C313GY

Product code	Description	Pack qty
56C313GY	Grey (with enclosure)	1

- **Standard of compliance:**  
IEC 60529  
BS 1363

1 3A 250V 1 gang socket with RCD



56C3134ELGY

Product code	Description	Pack qty
56C3134ELGY	Grey (with enclosure)	1

1 3A 250V 2 gang socket with RCD

Product code	Description	Pack qty
56C31324ELGY	Grey (with enclosure)	1

## Junction box

1 gang



56JB1GY

Product code	Description	Pack qty
56JB1GY	Grey (with enclosure)	1

- **Standard of compliance:**  
IEC 60529  
BS 5733

OCCUPANCY  
& PRESENCE  
DETECTION



# Occupancy & Presence detection



## **ARGUS Presence Detector System:**

Enjoy the fully networked presence detector solution offered by the Argus range, as well as stand-alone options for individual requirements



## **Stand-alone Occupancy Sensors**

The Schneider Electric occupancy sensor range combines a selection of outdoor passive infrared devices, and indoor ceiling or wall mountable devices to meet your energy saving needs.

# Argus presence detector system

The Argus presence detector range offers efficient stand-alone and system solutions for the different requirements of your customers: daylight harvesting for consistent brightness by the use of 1-10V and DALI as well as the control of heating or ventilation.

Networking presence detectors increases the detection areas, thus providing a close detection of larger rooms and areas as required.



## **Master/Slave**

Up to 10 masters and 10 slaves can be interconnected via a single core 230V cable. This means long corridors and large stairwells are easy to monitor.

## **Control via a retractive switch**

The overshoot time that has been set can be activated via a retractive switch.

## **Staircase timer**

Depending on requirements, the staircase timer can be infinitely adjusted between 10 seconds and 30 minutes.

## **Two channels for integrating heating or ventilation**

The first channel automatically controls the lighting depending on brightness and presence; the second channel controls connected loads such as heating or ventilation depending on presence only.

ARGUS



# Argus presence detectors

## Master with IR, relay



MTN55101119

Product code	Description	Pack qty
MTN55101119	1 gang	1
MTN55101219	2 gang	1

### Functions:

- Switching of one output.
- External triggering via one PL-input (Slaves).
- Switching.
- Brightness-dependent staircase lighting function.
- **MTN55101219** - with channel 1, staircase lighting function independent of brightness with channel 2.

- **Technical notes:**  
For ohmic, inductive and capacitive loads such as incandescent lamps, energy-saving lamps, LV halogen lighting with conventional transformer, electronic transformers, fluorescent lamps.

## Master with IR, 1-10V



MTN55101419

Product code	Description	Pack qty
MTN55101419	Master with IR, 1-10V	1

### Functions:

- Switching & dimming of one output.
- External triggering via one PL-input (Slaves).
- Memory function.
- Brightness-dependent staircase lighting function.

- **Technical notes:**  
For fluorescent lamps with electronic ballast or electronic transformer with 1-10V interface. The switchable light control ensures that the room illumination remains almost constant. The sensor module continuously measures the brightness in the room and adjusts the illumination to an adjustable setpoint.

## Master with IR, DALI



MTN55101519

Product code	Description	Pack qty
MTN55101519	Master with IR, DALI	1

### Functions:

- Switching & dimming of DALI EBs.
- External triggering via one PL-input (Slaves).
- Overload and short-circuit proof.
- Memory function.
- Up to 6 DALI control inserts can be connected to one DALI line. However, the maximum number of 64 DALI Ebs and a cable length of 300m must not be exceeded.
- Brightness-dependent staircase lighting function.

- **Technical notes:**  
For triggering up to 15 DALI Ebs. The switchable light control ensures that the room illumination remains almost constant. The sensor module continuously measures the brightness in the room and adjusts the illumination to an adjustable setpoint.

## Slave



MTN55701019

Product code	Description	Pack qty
MTN55701019	Slave	1

### Functions:

- Global control via four PL-outputs.
- Staircase lighting function independent of brightness.

- **Technical notes:**  
For triggering all Argus presence masters; the device has four PL-outputs. The control function via PL requires a separate core in the installation to the receiving master devices for each PL line.



## Surface mounted back box



MTN550619

Product code	Description	Pack qty
MTN550619	Surface mounted back box	1

## Flush mounted back box



ALB71322

Product code	Description	Pack qty
ALB71322	Flush mounted back box	1

## Side controller plus, complete unit



MTN51290319

Product code	Description	Pack qty
MTN51290319	Side controller plus, complete unit	1

**Functions:**

- Line control via one PL-output.
- Triggering master devices (right buttons).
- Activating the 24h staircase timer (left buttons).

**Nominal voltage:**

AC 220/230V, 50/60Hz.

**Output:**

1 x PlusLink.

**Neutral connector:**

Not required (2 conductor system)

**Wire range:**Max. 2x2.5mm<sup>2</sup>.**Accessories:**

PlusLink expander CCTDT5130.

• **Technical notes:**

For triggering all Argus presence masters. The device has one PL-output. The control function via PL requires a separate core in the installation to the receiving master and secondary devices. With screw terminals. With claw and screw fixing transformers, fluorescent lamps.

## IR remote control, distance 2010



MTN570222

Product code	Description	Pack qty
MTN570222	IR remote control, distance 2010	1

**Battery:**

2 microcells (IEC LR 03, AAA).

**Range:**

Up to 20m.

**Contents:**

Without battery.

• **Technical notes:**

10 channel IR remote control.

## PlusLink expander



CCTDT5130

Product code	Description	Pack qty
CCTDT5130	PlusLink expander	1

**Nominal voltage:**

AC 220/230V.

**Neutral connector:**

Required (3 conductor system).

**Wire range:**Max. 4mm<sup>2</sup>.**Device width:**

1HP=18mm.

• **Technical notes:**

The PlusLink extension needs to be integrated into one or more PL-lines if there are protected by at least two circuit breakers. If a circuit breaker is triggered in the event of maintenance work or a fault, then the PlusLink expansion will disconnect the PlusLink line automatically as well. This is necessary because the PlusLink line would otherwise continue to be live via the other circuit breakers. With screw terminals. Suitable for installation on DIN rails TH35 according to EN 60715.

# Stand-alone Detectors

By leveraging state of the art infra-red, and combined ultrasonic and infra-red (dual technologies), our ultra sensitive occupancy sensors offer you the ultimate in reliable, efficient and cost effective lighting control.

This provides a quick and environmentally friendly way of reducing energy consumption with easy setup. Compared to a traditional manual switch, there are significant potential energy savings that can be achieved by utilising occupancy sensors.

The Schneider Electric occupancy sensor range combines a selection of outdoor passive infra-red devices, and indoor ceiling or wall mountable devices.



STAND-ALONE  
DETECTORS



# Indoor sensors

## 360° ceiling mounted



SAEUEMSCUWE



SAEUEMSCSAWE

Product code	Description	Pack qty
SAEUEMSCUWE	PIR & ultrasonic	1
SAEUEMSIR10T	Remote control for SAEUEMSCUWE	1
SAEUEMSCSAWE	Single-load PIR	1
SAEUEMSCDBWE	Dual-load PIR	1

- Technical notes:**  
 Flush or surface mounted;  
 SAEUEMSCDBWE flush mount only. 7m at 2.5m height range; SAEUEMSCUWE 12m x 18m at 2.5m height range.

## Infra-scan 120° wall mounted



E751 &amp; E751R

Product code	Description	Pack qty
E751	2A PIR	1
E751R	10A PIR	1

- Technical notes:**  
 Surface mount.  
 Detection area 6m x 6m at 2.4m height range.

## PIR plate switch wall mounted



GUPA1411BSS

Product code	Description	Pack qty
GUPA1411BSS	PIR plate switch wall mounted with override	1
GUP1411BSS	PIR plate switch wall mounted	1

- Technical notes:**  
 Field of view: 90°.  
 Range: 5m at 1.2m height. Time setting: 15sec - 30min. Stainless steel with black interior finish only.

# Outdoor sensors

## Single-load PIR



CCT56P004



CCT56P008

Product code	Description	Pack qty
CCT56P004	120°	1
CCT56P008	360°	1

- Technical notes:**  
 Detection field up to 18m. Includes separate mounting base. Base includes conduit entries. Suitable for wall or ceiling mounting.

## Infrascan single-load PIR



E750WPRGY

Product code	Description	Pack qty
E750WPRGY	110°	1

- Technical notes:**  
 Detection field up to 18m. Includes separate mounting base. Base includes conduit entries. Suitable for wall or ceiling mounting.

CLIPSAL  
C-BUS























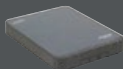



# Innovative control systems for commercial or residential...

Take advantage of the benefits a fully programmable and customisable control system can provide. Introducing Clipsal, a system that can deliver a complete lighting and room control solution to help you achieve your goals, whether in residential or commercial applications.

In homes, C-Bus offers a total control solution ensuring that your property is secure, entertaining, exciting, relaxing, beautiful and you.

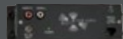
For commercial projects you will find a various options for intelligent building control which offer not only improved comfort, but also provide significant energy savings.

<b>C-Bus Input Units</b>	Wall Switches 	Touch Screen Controllers 	Occupancy Sensors 	Environment Sensors 	General Input Units 	Handheld IR Remotes 
<b>C-Bus Output Units</b>	DIN Rail Dimmers 	DIN Rail Relays 	Blind control relay 	1 & 2 channel relay range 	Extra Low Voltage Relay 	Infrared Transmitters 
<b>C-Bus System Units and Accessories</b>		Controllers 	Network Support Devices 	Gateways 	Network analyser 	
<b>C-Bus Software</b>	Toolkit software 	PICED software 	OPC Server software 	Schedule Plus 	HomeGate software 	
<b>C-Bus Multi-Room Audio</b>	Matrix Switcher 	Amplifier power supply 	Distribution unit 	Amplifiers accessories 		

# The best just got better...

Introducing our new Saturn eDLT range

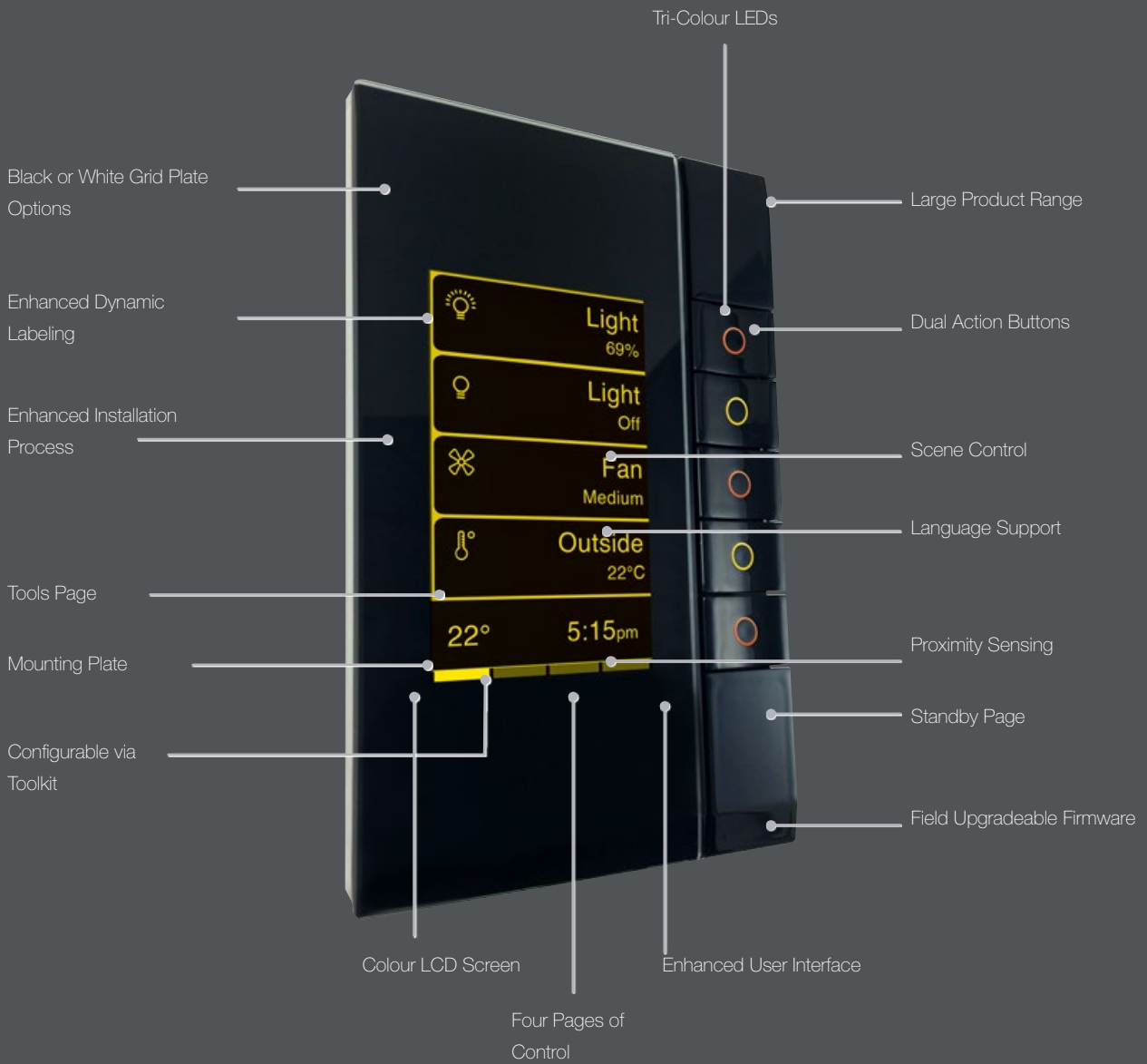



# Saturn eDLT...

With the ability to customise the colour of the display and button, advanced device control, and intuitive functionality, the eDLT offers fantastic features and benefits that will enhance and complement your lifestyle.

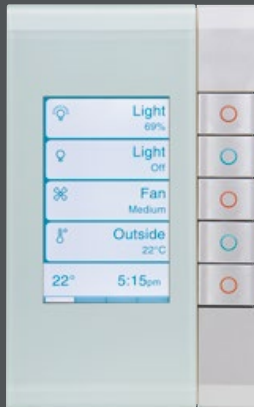

## Customisable Colour Options

Select from eight colour options to customise the screen and buttons to suit your style. The eDLT can also indicate system information for you, such as high energy use (red) or security disarmed (green).



## Scene Control

The eDLT simplifies living by integrating multiple technologies around your home to work in unison at the touch of a button.

For example; a "Movie" scene for your home theatre could dim the lights, turn on the projector and lower the screen; or a "Goodnight" could scene could conveniently turn off all the lights in your home from the comfort of your bedroom.



## Enhanced Control Capability

The eDLT replaces the need for multiple wall switches, and provides you with up to 16 control functions in one stylish unit.



# Technical information



# ARGUS presence detector system

## ARGUS presence detector system

Product Code	MTN55101119	MTN55101219	
Description	Presence Master with IR, relay 1-gang	Presence Master with IR, relay 2-gang	
Nominal voltage	AC 220/230V, 50/60Hz	AC 220/230V, 50/60Hz	
Nominal current	max. 10AX, $\cos\varphi = 0.6$	Max. 10AX, $\cos\varphi = 0.6$ . The total load on both channels is not allowed to exceed 14A	
Control current	-	-	
Type	-	-	
Load type	-	-	
Outputs	1 x make contacts	2 x make contacts	
<b>Max. switching capacity per channel:</b>			
Incandescent lamps	2200W	2200W	
HV halogen lamps	2000W	2000W	
LV halogen lamps with wound transformer	500VA	500VA	
Electronic transformers	1050W	1050W	
Capacitive load	10A, 140 $\mu$ F	10A, 140 $\mu$ F	
Energy-saving lamps	100VA	100VA	
Motor load	1000VA	1000VA	
Neutral conductor	Required (3 conductor system)	Required (3 conductor system)	
Cable capacity	max. 2x2.5mm <sup>2</sup>	max. 2x2.5mm <sup>2</sup>	
Angle of detection	360°	360°	
Number of levels	6	6	
Number of zones	136	136	
Number of movement sensors	4	4	
Recommended installation height	2.5m	2.5m	
Range	A radius of max. 7m (at an installation height of 2.5m)	A radius of max. 7m (at an installation height of 2.5m)	
Sensitivity	Continuously adjustable	Continuously adjustable	
Brightness threshold	Continuously adjustable between approx. 10 and 1000 lux	Continuously adjustable between approx. 10 and 1000 lux	
Overshoot time	Channel 1: continuously adjustable between approx. 10s and approx. 30min	Channel 1: continuously adjustable between approx. 10s and approx. 30min	
		Channel 2: continuously adjustable between approx. 5min and approx. 2h	
Slave	ARGUS Presence Slave MTN55701019	ARGUS Presence Slave MTN55701019	

# ARGUS presence detector system

	MTN55101419	MTN55101519	MTN55701019
	Presence Master with IR, 1-10V	Ultimate screwless	Presence Slave
	AC 220/230V, 50/60Hz	230V 50Hz	AC 220/230V, 50/60Hz
	max. 10AX, $\cos\varphi = 0.6$	90°	-
	max. 50mA	5m at 1.2m height	-
	-	Wall (flush)	-
	max. 25 controllable EBs (1-10V)	Single	-
	1 x make contact, 1 x (1-10V)	X	4 x PL
	2200W	-	-
	2000W	-	-
	500VA	-	-
	1050W	-	-
	10A, 140 $\mu$ F	-	-
	-	-	-
	-	-	-
	Required (3 conductor system)	Required (3 conductor system)	Required (3 conductor system)
	max. 2x2.5mm <sup>2</sup>	max. 2x2.5mm <sup>2</sup>	max. 2x2.5mm <sup>2</sup>
	360°	360°	360°
	6	6	6
	136	136	136
	4	4	4
	2.5m	2.5m	2.5m
	A radius of max. 7m (at an installation height of 2.5m)	A radius of max. 7m (at an installation height of 2.5m)	A radius of max. 7m (at an installation height of 2.5m)
	Continuously adjustable	Continuously adjustable	Continuously adjustable
	Continuously adjustable between approx. 10 and 1000 lux	Continuously adjustable between approx. 10 and 1000 lux	-
	Channel 1: continuously adjustable between approx. 10s and approx. 30min	Channel 1: continuously adjustable between approx. 10s and approx. 30min	Channel 1: continuously adjustable between approx. 10s and approx. 30min
	ARGUS Presence Slave MTN55701019	ARGUS Presence Slave MTN55701019	-

# Occupancy sensors technical overview

	Ceiling Mounted				
Product Code	SAEUEMSCUWE	SAEUEMSCSAWE	SAEUEMSCDBWE	E75 1	
Product Description	Single-Load 360° PIR and Ultrasonic Sensor	Single-Load 360° PIR Sensor	Dual-Load 360° PIR Sensor	Infrascan single-load 120° PIR sensor	
Operating voltage	230V 50/60Hz	230V 50/60Hz	230V 50/60Hz	200-265V 50Hz	
Field of view	360°	360°	360°	120°	
Range	12m×18m at 2.5m height	7m at 2.5m height	7m at 2.5m height	6m x 6m, 8.5m from sensor head. Head rotatable through 120°	
Mounting	Ceiling (surface / flush)	Ceiling (surface / flush)	Ceiling (flush)	Ceiling (surface)	
Single or Dual Load:	Single	Single	Dual	Single	
IR Remote Control*	SAEUEMSIR10T	X	X	X	
Incandescent	2000W	2000W	2000W	2A	
Halogen lamps 230V	1000W	1000W	1000W	2A	
Halogen w. Electronic transformer	1000VA	1000VA	1000VA	2A (iron core transformer only)	
Fluorescent tubes	900VA/100µF	900VA/100µF	900VA/100µF	X	
Energy Saving lamps	900VA	900VA	900VA	X	
IP class	IP20	IPX0	sensor IP40 , power box IP20	IP44	
Time setting	Time 1 (for lighting): Adjustable from 5 sec to 20 min Time 2 (for HVAC): Adjustable from 10 sec to 60 min	5 sec to 20 min	Time 1 (for lighting): Adjustable from 5 sec to 20 min Time 2 (for HVAC): Adjustable from 10 sec to 60 min	5 sec to 20 min (user adjustable)	
Test Mode	Yes	Yes	Yes	Yes	
Lux setting	10 - 2000 Lux	10 - 2000 Lux	10 - 2000 Lux	Continuous from 1 Lux to full sunlight	
Operating temp range	0°C to +50°C	0°C to +45°C	0°C to +45°C	0°C to +40°C	
Connection	3-wires	3-wires	3-wires	2 wires	
Parallel connection of detectors	Yes	Yes	Yes	No	
Switching modes	Auto/Off	Manual on	X	Auto mode, manual override	
Product Dimensions	Ø111.5 x 72mm Ø111.5 x 43.5mm (flush) 68mmØ Cut-out	Ø111.5 x 59mm Ø111.5 x 30mm (flush) 65mmØ Cut-out	Ø80 x 16.5mm(H) 65mmØ Cut-out	Ø 100 x 57mm(H)	

# Occupancy sensors technical overview

		Wall Mounted		Outdoor		
	<b>E751R</b>	<b>GUPA1411BSS</b>	<b>GUP1411BSS</b>	<b>E750WPRGY</b>	<b>CCT56P004</b>	<b>CCT56P008</b>
	Infrascan Single-load 120° PIR sensor	Ultimate screwless 90° PIR plate switch - with override	Ultimate screwless 90° PIR plate switch	Infrascan single-load 110° PIR sensor	Single-load 120° PIR sensor	Single-load 360° PIR sensor
	200-265V 50Hz	230V 50Hz	230V 50Hz	200-265V 50Hz	220-240V 50Hz	220-240V 50Hz
	120°	90°	90°	110°	120°	360°
	6m x 6m, 8.5m from sensor head. Head rotatable through 120°	5m at 1.2m height	5m at 1.2m height	18m at 2.4m height	12m (forward)	12m
	Ceiling (surface)	Wall (flush)	Wall (flush)	Wall or ceiling (surface)	Wall or ceiling (surface)	Wall or ceiling (surface)
	Single	Single	Single	Single	Single	Single
	X	X	X	X	X	X
	10A	150W	150W	10A	1000W	1000W
	10A	150W	150W	10A	900W	800W
	10A	150VA	150VA	10A	250VA	315VA
	10A	X	X	10A	200VA	250VA
	500W	X	X	500W	4 x 23W	4 x 23W
	IP44	X	X	IP66	IP55	IP55
	5 sec to 20 min (user adjustable)	15 sec – 30 min (through 7 time increments)	15 sec – 30 min (through 7 time increments)	5 sec to 20 min (user adjustable)	Approx 3 sec – 3 min, lower tolerance 2 – 6s	Approx 5 sec – 20 min, lower tolerance 2 – 8s
	Yes	No	No	Yes	Yes	Yes
	Continuous from 1 Lux to full sunlight	10 - 2000 Lux	10 - 2000 Lux	Continuous from 1 Lux to full sunlight	5 – 2000 Lux	5 – 2000 Lux
	0°C to +40°C	+5°C to +25°C	+5°C to +25°C	0°C to +50°C	-15°C to +40°C	-15°C to +40°C
	3-wires	2 wires	2 wires	3-wires	3-wires	3-wires
	Yes	Yes	Yes	Yes	Yes	Yes
	Auto mode, manual override	Auto mode, manual override	X	Auto mode, manual override	Auto mode, manual override	Auto mode, manual override
	Ø 100 x 57mm(H)	88 x 88mm	88 x 88mm	Mounting centres 84mm	With corner bracket 164mm (L) x 80mm (W) x 75mm (H) without corner brackets 140mm (L) x 80mm (W) x 75mm (H)	With corner bracket 170mm (L) x 88mm (W) x 76mm (H) without corner bracket 142.5mm (L) x 88mm (W) x 76mm (H)

# Wiring accessories

## Recommended quantity of socket outlets for domestic installation

Inadequate installations can occur when not enough socket outlets have been installed or where the existing sockets are located in the wrong areas. This could lead to potentially dangerous improvisations.

The table below summarises the recommendations of the Electrical Installation Industry Liaison Committee (EILC) regarding the minimum number of twin switched socket outlets per room, suitable for domestic installations. This takes into account likely uses and likely trends.

Room	Number of sockets	Room	Number of sockets
Kitchen	4	Landing/stairs	1
Lounge	6	Hall	1
Dining room	3	Garage	2
Double bedroom	3	Store/workroom	1
Single bed-sitting room	3	Central heating boiler point	1

## Wiring circuits for 6AX and 10AX switches

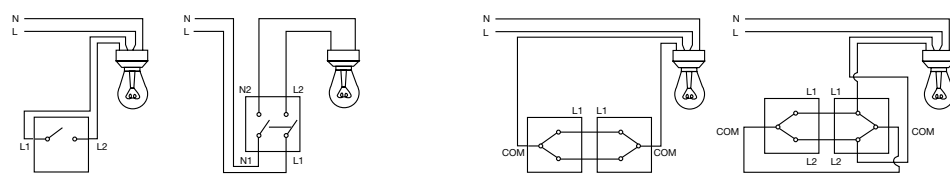

Diagram A – One way circuits

Diagram B – Two way circuits

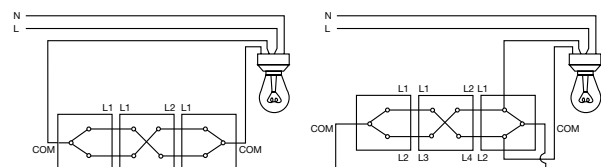

Diagram C – Intermediate circuits

**Note:** 1 way or 2 way switches can be replaced by dimmer switches. Rotary dimmers are 1 way only whilst Push dimmers are 2 way. LV dimmers are suitable for use on the LV input side only.

## Accessories mounting box

Product	Description	Ultimate white moulded	Exclusive white moulded	Ultimate metal plate	Exclusive metal plate
6AX/10AX plate switches	1-2 gang	16mm	16mm	16mm	25mm
	3 gang	25mm	25mm	25mm	25mm
	4-6 gang	25mm	25mm	25mm	25mm
	TP isolator	25mm	25mm	25mm	25mm
Dimmer switches	1 & 2 gang	**16mm/25mm	**16mm/25mm	25mm	25mm
	3 & 4 gang	25mm	25mm	25mm	25mm
Socket outlets	1 gang	25mm*/35mm	25mm	25mm*/35mm	25mm
	2 gang	25mm*/35mm	25mm	25mm*/35mm	25mm
	3 gang		25mm		
Round pin sockets		25mm	25mm	25mm	25mm
RCD socket outlets	1 & 2 gang		25mm		25mm
Fused connection units		25mm	25mm	35mm	25mm
Flex outlet plates		25mm	25mm		
20AX key switches		25mm	25mm	25mm	25mm
20AX DP switches		25mm	25mm	25mm	25mm
32A DP plate switches	1 gang	47mm	47mm		47mm
	2 gang	47mm	47mm	47mm	
45A DP switches	1 gang	47mm	47mm		47mm
	2 gang	47mm	47mm	47mm	
45A DP ceiling switch			47mm		
Cooker connection units		47mm	47mm	47mm	47mm
Cooker terminal box		47mm	47mm		
Shaver sockets		47mm	47mm		47mm
Telephone socket outlets	Master & secondary	25mm	25mm	25mm	25mm
Co-axial socket outlets	Single & twin	25mm	25mm	25mm	25mm
Diplex and triplex		25mm	25mm	35mm	25mm
Satellite socket		25mm	25mm	25mm	25mm
RJ45 & RJ11		35mm	35mm	35mm	35mm

**Note:** Metal clad accessories are supplied complete with a 42mm surface mounted box in the same matching finish. Metal plate accessories are not suitable for mounting on surface moulded pattresses.

\*Dependent upon wiring configuration

\*\*For 16mm flush fitted steel boxes use adaptor plate supplied when mounting 2 Way Ultimate slim line moulded dimmer switches



# Wiring accessories

## Dimmer switches

General Information:

When specifying dimmers it is advisable to obtain as much information as possible to ensure suitability and compatibility of products.

Consider the following:

- Type of lamps/lighting
- Type of control gear used in the light fittings, (if applicable) e.g. type, make and model number of transformer or ballast, etc
- Number of light fittings/load of each dimmer
- Number of circuits/dimmers
- Number of dimmers on each plate
- Number of switching positions for each circuit
- Any requirement for dimming lights from more than one position

### 1 gang plate size

Dimmer modules	Max.each dimmer	Min.each dimmer	Total per plate
1	250W	60W	250W
1	400W	60W	400W
1 (Electronic)	300VA	60VA	350VA
2	250W	60W	500W
2 (Electronic)	200VA	60VA	400VA

Maximum load of 400W for the plate should not be exceeded.

Dimmer modules	Max.each dimmer	Min.each dimmer	Total per plate
1	1000W	100W	1000W
3	250W	60W	750W
4	250W	60W	1000W

Maximum load of 1000W for the plate should not be exceeded.

Schneider Electric mains dimmers are NOT designed for dimming with any form of Low Voltage transformer. For this application a suitably rated Low Voltage Dimmer Switch should be used.

### Maximum permitted loads in Watts for multiple dimmers in a single enclosure

Front plate gang size	2	3	4	6	8	9	12	18	24
Per row (max rating W)	400	480	480	480	480	480	480	480	480
Total plate (max rating W)	400	480	480	740	740	940	940	1440	1800

## Dimmer guidelines

Moulded plate mounted dimmers can generally be used with the supplied pattress to replace standard wall switches (where a 16mm box depth is typically used). For flat plate mounted dimmers, 25mm boxes are required, except for the 1000W Electronic dimmer that requires a 47mm box. All rotary dimmer terminations and wiring are the same as for standard switches, i.e. COM, L2 (and also L1 for two-way dimmers). Rotary one-way dimmers can only be used for switching and dimming from one position. Rotary two-way (push) dimmers can be used to replace any one, (but not both), of the two-way switch circuit, (note that only one dimmer can be used per switch circuit or lamp(s); thus the lights can be switched from more than one position but can only be dimmed from one. With any rotary dimmer, if replacing an existing switch or dimmer, make a careful note of which wires are installed in which terminals on the old unit, and then connect them into the terminals with corresponding markings on the new dimmer. To ensure that plate temperatures are within maximum limits, maximum total connected load for a single size plate is 630W, and for a double size plate is 1000W. For Low Voltage lighting, remember to allow for transformer losses when calculating the total circuit load, typically 15% - 20%.

To use electronic dimmers in 1, 2 or more way circuits the circuit diagrams below and the Important Notes MUST be followed exactly.

### Simulated 'Off - Click'

Recent developments within the industry have resulted in rotary dimmer modules not having the positive 'Off Click' as the dimmer is switched off. This has led to consumers returning product identifying they are not functioning. To counter this Schneider Electric have a 'simulated Off'. The range has been designed to withstand a higher inrush current than others in the market. This inrush is typical when lamps turn on for the lamps 'blow'. Typically this inrush or energy surge can be up to 100 times the normal current being supplied to a lamp. For example the inrush for a 150W lamp could be up to 40NS over 10 milliseconds. A number of dimmer products in the market when tested have a maximum capacity of approximately 20NS. The Schneider Electric product has an equivalent capacity of 50NS. This, therefore means that the Schneider Electric product will last longer within installations, depending on the switching duty. A thermal fuse protects the Schneider Electric module. This will not protect the unit against an inrush but against overloads and short-circuits etc. This fuse is not self restoring or replaceable. It's function is to protect against electrical and fire damage. This requirement was not mandatory in the previous standard and therefore some modules in circulation potentially do not have the safety feature, unlike ours.

### Tungsten/Mains Voltage Tungsten Halogen Lighting

Most Tungsten lamps can be dimmed; these include standard GLS lamps, candle lamps, reflector and mains voltage Tungsten Halogen lamps etc. Tungsten lamps of mains voltage halogen type (GZ10, GU10 or G9) can be dimmed using standard Tungsten dimmers. However, to protect the dimmer, it is important to de-rate the dimmers maximum rating by 50%, (e.g. for dimmer rated as SOW- 400W, it's Tungsten Halogen lamp rating becomes SOW- 200W). This de-rating requirement only applies to Plate and Grid dimmers rated up to 1500W, for other dimmers, observe individual product guidelines. While observing maximum dimmer ratings, also ensure that the connected load is not less than the minimum rating of each dimmer, otherwise the lamps may flicker and the dimmer may fail.

# Wiring accessories

## 1 way installation wiring diagram

**IMPORTANT NOTES - for 1 Way Installation**

1. Read General Installation Safety Instructions before starting work
2. Do not connect any conductor to dimmer terminal marked RS. This is for use with 2 way switching

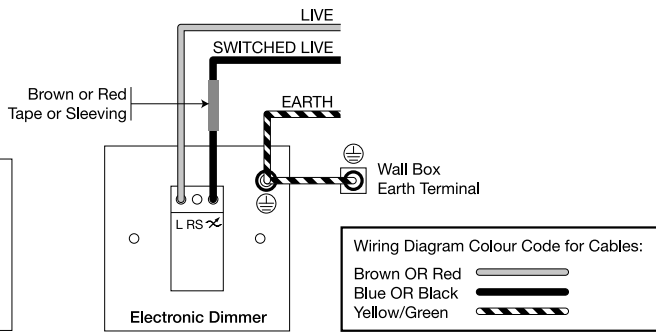

## 2 way and multi-way installation wiring diagram

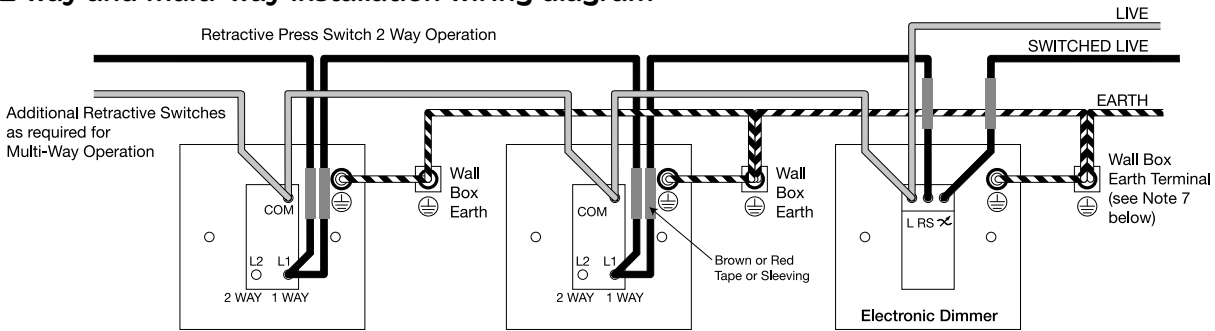

### Important notes - for two way and multi - way installation

1. Read General Installation Safety Instructions before starting work.
2. Any existing 2 Way or Intermediate dimmers MUST be replaced with Retractive Press Switches.
3. Any number of Retractive Press Switches may be installed provided total cable length does not exceed 50m.
4. Either 1 Way normally open or 2 Way Retractive Push Switches may be used.
5. If 2 Way retractive switches are used, connect to Common (COM) and normally open L1 (1 WAY) terminals as shown. Do NOT use the L2 (2 WAY) terminal.
6. If replacing an existing 2 Way switch, cut back and insulate the unused 2 way wire previously connected to the L2 (2 way) terminal.
7. All Metal Wall Boxes and Metal Plate Switches must be earthed.
8. Do NOT connect more than 1 Dimmer in the same circuit,
9. Remove label covering centre terminal on rear of dimmer. This terminal is to be connected to Retractive Switch as shown in wiring diagram. Do NOT connect any other conductor to this terminal.

### Circuit, lamp and other equipment compatibility

To ensure optimum performance and reliability is obtained from dimmer switches the following recommendations and precautions should be followed as appropriate to the type of dimmer:

## General recommendations

### Circuits

It is recommended that all lighting circuits incorporating dimmers be protected by a 6A or up to a 10A maximum Type B miniature circuit breaker.

### Tungsten halogen lamps

When using mains voltage Tungsten Halogen lamps, it is essential that these types of lamp incorporate internal fuses or are constructed such that arcing at the end of life cannot occur and are from quality lamp manufacturers. The use of inferior low quality lamps is not recommended and will invalidate any guarantee or warranty supplied with the dimmer switch.

### Dimmable low voltage transformers

- Always check transformer compatibility BEFORE installation and if in doubt always check with the dimmer Helpline or the transformer manufacturer. It is recommended that electronic dimmable transformers be loaded to at least 70% of their rated maximum wattage.
- When running multiple lamps on dimmable electronic transformers ensure that all lamps are working correctly. Replace failed lamps as soon as possible as a single failed lamp may cause flickering of all other lamps connected to the same dimmer.
- Do NOT mix electronic and magnetic transformers on the same dimmer switch.
- It is recommended that a maximum number of 5 Low Voltage transformers only should be connected to an individual dimmer switch.

## Electronic dimmers

### Circuits

- For two-way or more switching ONLY use retractive switches. Do NOT use two-way switches.
- The live supply for retractive switches must come from the live (L) connection of the dimmer.

### Lamps

- Do NOT use with Compact Fluorescent Lamps (CFL) even if marked "dimmable", Fluorescent lamps and Light Emitting Diode (LED) lamps of any description or motor loads.

### Dimmable low voltage transformers

- These Electronic dimmer switches, except the 1kW, use leading edge (phase delay) dimming technology and must therefore be used with compatible good quality dimmable electronic or wire-wound (magnetic) transformers. Trailing edge (phase cut) dimmable transformers must not be used.
- The 1kW dimmer switch uses trailing edge (phase cut) dimming technology and must therefore be used with compatible good quality dimmable electronic transformers. Do not use the 1kW dimmer with magnetic transformers.

# Wiring accessories

## Rotary and 2 way (push) dimmers

### Circuits

■ Only use two-way (push) dimmers in two-way switching circuits. Only use one two-way dimmer in a two-way switching circuit.

### Lamps

- These dimmer switches are suitable for dimming incandescent lamps and dimmable CFL lamps only and are NOT to be used with Fluorescent lamps, Light Emitting Diode (LED) lamps of any description or motor loads. Use of non-dimmable CFL lamps may permanently damage the dimmer or the lamp and will invalidate any guarantee or warranty supplied with the dimmer switch.
- It is recommended that a maximum number of 5 dimming CFL lamps only should be connected to an individual dimmer switch.

### Dimmable low voltage transformers

- Only use Low Voltage dimmers with transformers. Do not use mains voltage dimmers.
- The Low Voltage dimmer switches use leading edge (phase delay) dimming technology and must therefore be used with compatible good quality dimmable electronic or wire-wound transformers. Trailing edge (phase cut) dimmable transformers must not be used.

## Co-Axial and Satellite sockets

### Non isolated

Non-isolated products are intended for direct connection to a single or two separate TV/FM aerial downloads. These units are not designed for use in multi outlet systems.

Single TV/FM outlet for connection to a single TV or FM coaxial aerial lead.

Twin outlet for connection to each of two separate TV/FM, coaxial aerial leads.

## Diplex and Triplex

### Performance

#### Diplex

TV/FM diplex units for connection to a single coaxial aerial lead with combined TV and FM signals.

The connector standard IEC 169-2 plug for TV and IEC 169-2 socket for Radio.

#### Triplex

TV/FM/SAT triplex unit for connection to a single coaxial aerial lead with combined TV, FM and satellite signals.

TV: 470-860MHZ

Radio: (FM) 87.5 – 108 MHz and (DAB) 217.5 – 230 MHz.

Satellite: DC – 200kHz and 950-2300MHz.

The connector standard is 'f' for satellite, IEC 169-2 plug for TV and IEC 169-2 socket for Radio.

## Telephone socket outlets

It is legal for a contractor to install a secondary telephone socket with associated wiring into house-holds with single exchange lines. The contractor may install a secondary socket and wire up to the master socket and wiring to the exchange. This does not include wiring the actual master socket or to the exchange itself. this final connection must be made by an approved installer.

For commercial and industrial installations a PBX (or PABX) internal exchange or 'intelligent' telephones are often fitted. In this case, the contractor may install all of the equipment except for the PBX unit installation. Again this must be carried out by a BSI approved installer and the interface between the PBX/PABX internal system and the incoming external lines must be connected by British Telecom.

Schneider Electric telephone sockets are suitable for use in accordance with BS 7671, formerly the 16th Edition of the IEE Wiring regulations and should be wired in accordance with the diagrams shown.

### Example of typical connection

1 Connection to 2 & 5

2 Earth recall (when used) connect to terminal 4

3 Connection to terminal 3 is not usually required

**NB** (a) Standard 4 wire cable is shown below as incoming cable. If terminals 1 and 6 (normally unused) are required, 6 wire cable may be used.

(b) All socket outlet connections are parallel – any number of socket outlets can be connected, but it is recommended that only a maximum of 5 telephones be used at any one time on one line.

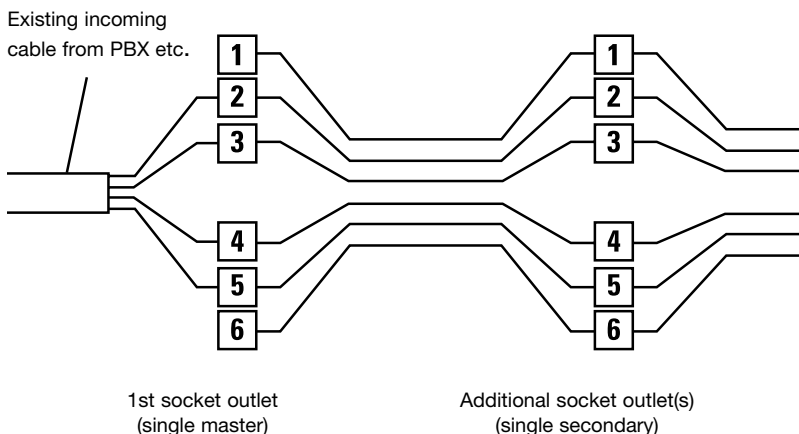

# 56 Series plastic chemical resistant comparison chart

Product Type (Colour)	All mounting enclosures (ie back box)	Grey transparent covers and plugs	Resistant orange (RO) covers and plug s
<b>Acids</b>			
<b>Weak Solutions</b>			
Hydrochloric	A	A	A
Nitric 10% Concentrate	A	A	A
Sulphuric Acid 100%	A	D	D
<b>Alkalis</b>			
<b>Weak Solutions</b>			
Sodium Hydroxide 10% (Caustic Soda) Concentrate	A	D	B
Potassuim Hydroxide 100%	A-B	D	D
<b>Automotive</b>			
Petroleum	A	D	A
Lubricating Oils		D	A
Hydraulic Oil		D	A
<b>Solvents</b>			
<b>Aliphatic hydrocarbons (alkanes)</b>			
Methane	B	A	A
Propane	A	A	A
<b>Alcohols</b>			
Ethelene Glycol	A	A	A
Glycerol (Glycerin)	A	C	B
Methyl Alcohol (Methanol)	A	D	B
Ethyl Alcohol (Ethanol)	A	A	A
<b>Amines</b>			
Aniline	D	D	D
<b>Aromatic Hydrocarbons</b>			
Methyl Benzene	D	D	B
Xylene	D	D	B
<b>Ethers</b>			
Dimethyl Ethyl	A	A	A
<b>Ketones</b>			
Acetone	A	D	C
Acetophenone	D	D	C
Ethyl Methyl Ketone	D	D	C
<b>Miscellaneous</b>			
Detergent	A	A	A
Inorganic Salts			
Magnesium Sulphate	A	A	A
<b>Oxidising agents</b>			
<b>Weak Solution</b>			
Sodium Hydrochlorite 5%	A	A	A
<b>Strong Solution</b>			
Hydrogen Peroxide 30%	A	A	A
<b>Water</b>			
Ambient	A	A	A
Hot >60°C	C	A	B
Steam	D	D	D

This table should be used as a guide only. Any end user should test to evaluate the suitability of any chemical with any plastic.

**A - Excellent**  
Recommended no adverse effects after extended exposure.







**B - Good**  
Acceptable minimal loss of mechanical properties after long periods of exposure.

**C - Fair**  
Marginal acceptability.

**D - Poor**  
Not recommended for use.

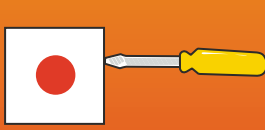





# Ingress Protection ratings

## PROTECTION AGAINST SOLIDS

	TEST	PROTECTION
<b>x</b>	No test applied	No specific protection
<b>0</b>	No test applied	Inherent degree of protection
<b>1</b>		Protected against solid objects equal to or greater than 50mm diameter. (eg. accidental contact with hand)
<b>2</b>		Protected against solid objects equal to or greater than 12.5mm diameter. (eg. contact with finger)
<b>3</b>		Protected against solid objects equal to or greater than 2.5mm diameter. (eg. tools and wires)
<b>4</b>		Protected against solid objects equal to or greater than 1mm diameter. (eg. fine tools and wires)
<b>5</b>		Protected against quantities of dust that could interfere with satisfactory operation.
<b>6</b>		Completely protected against dust.

Defined by IEC 60529  
DIN 40050 CEI 70-1

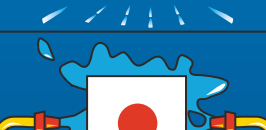
## PROTECTION AGAINST LIQUIDS

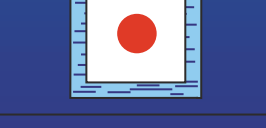
	TEST	PROTECTION
<b>x</b>	No test applied	No specific protection
<b>0</b>	No test applied	Inherent degree of protection
<b>1</b>		Protected against drops of water falling vertically.
<b>2</b>		Protected against drops of water falling at up to 15 degrees from the vertical.
<b>3</b>		Protected against spraying water at up to 60 degrees from the vertical.
<b>4</b>		Protected against splashing water from all directions.
<b>5</b>		Protected against jets of water from all directions.
<b>6</b>		Protected against jets of water of similar force to heavy seas.
<b>7</b>		Protected against the effects of temporary immersion.
<b>8</b>		Protected against the effects of continuous immersion.

Defined by IEC 60529

# Index

Reference	PG	Reference	PG	Reference	PG	Reference	PG	Reference	PG
400102	160	56E9GY	194	56SW363LEGY	190	E55CB	178	GBG04F	74
400104	160	56ED2GY	193	56SW363LERO	190	E55GP	178	GBG04F	46
400112	160	56ES1GY	193	56SW420LEGY	191	E55PB	177	GBG04F	46
400113	160	56ES2GY	193	56SW420LERO	191	E727WE	167	GBG04S	150
400114	160	56ES2RO	193	701WE	171	E750WPRGY	205	GBG04S	150
3746130	17	56FA1GY	194	9WE	167	E751	204	GBG06F	19
3746130	44	56FA2GY	194	ADAPT2W	160	E751R	204	GBG06F	74
3746130	72	56FA3GY	195	ADAPT3WF	160	E93WE	157	GBG06F	74
3746130	91	56FA4GY	195	ALB71322	201	ED45NWE	166	GBG06F	46
3746130	114	56FCUGY	189	CCT56P004	205	ET01E	167	GBG06F	46
3746130	130	56FCULEGY	189	CCT56P008	205	ET238WE	171	GBG06S	150
3746130	141	56JB1GY	195	CCTDT5130	201	ET36WE	168	GBG06S	150
301SMWE	169	56L1GY	192	CRB2W	159	G45ACCU	128	GBGS01	149
302SMWE	169	56L2GY	193	CSC313	182	G45ACCUN	128	GBGS01	149
30FSWE	170	56P310GY	192	CSO313	182	G45CX	129	GBGS02	149
30M35WE	169	56P310GY	194	CSO3132	182	GABAT	156	GBGS02	149
30MBPNWE	169	56P310RO	194	CSW120	182	GABATC	156	GBGS03	149
30MBPRWE	169	56P313EO	192	CSW1202	182	GADAPTSVR	129	GBGS03	149
30MBPWE	169	56P313GY	192	CSW220	182	GBAT	156	GBGS04S	150
30MD20WE	169	56P313RO	192	E15DWE	164	GBATC	156	GBGS04S	150
30MIWE	169	56P315GY	192	E15WE	164	GBG01	18	GBGS06S	150
30NGR	170	56PBS1LEGY	191	E238WE	171	GBG01	44	GBGS06S	150
30NRD	170	56SO313GY	188	E251BP	164	GBG01	44	GBLANK1G	130
30PFMWE	170	56SO313LEGY	188	E251WE	164	GBG01	72	GBLANK2G	130
30PWE	167	56SO313RO	188	E25CESFNWE	164	GBG01	72	GCKR50A	128
30RJ45SMA5SHWE	170	56SO316110LEGY	188	E25DF32BP	164	GBG01	92	GCKR50A2G	128
30RJ45SMA6SHWE	170	56SO3166LEGY	188	E25DF32WE	164	GBG01	92	GCKRN50A	128
30SFMOP	170	56SO3326LEGY	188	E25DWE	164	GBG01	114	GCKRN50A2G	128
30TKMWE	169	56SO332GY	188	E25NWE	164	GBG01	149	GD1G1W	126
30TV75MSWE	170	56SO4166LEGY	188	E25SFWE	164	GBG01	149	GD1G2W4C	126
30USMWE	169	56SO4326LEGY	189	E25WE	164	GBG01P	149	GD1G2WC	126
30WE	166	56SO5166LEGY	188	E30FSGWE	166	GBG01P	149	GD2G2WC	126
31J	167	56SO520LEGY	188	E311SAWE	165	GBG02	18	GDL1	159
32E450LMWE	169	56SO5326LEGY	189	E312SAWE	165	GBG02	73	GDL1	159
32E450TMWE	169	56SSW10LEGY	191	E312XWE	167	GBG02	73	GE115P	160
32WE	168	56SSW15LEGY	191	E319WE	165	GBG02	92	GE115S	161
39MWE	169	56SSW15LERO	191	E31DFSGNWE	166	GBG02	92	GE125P	160
5632LEGY	192	56SSW210LEGY	191	E311AWE	165	GBG02	114	GE157P	160
5632LERO	192	56SSW215LEGY	191	E31WE	168	GBG02	149	GE197P	160
56C31324ELGY	195	56SW110GY	189	E31WP23SAWE	165	GBG02	149	GE249P	160
56C3134ELGY	195	56SW110LEGY	189	E31WPWE	168	GBG02	45	GE321P	160
56C313GY	195	56SW110LERO	189	E31XWE	167	GBG02	45	GE381P	160
56CB4GY	192	56SW120LEGY	189	E322SAWE	165	GBG02P	149	GE84S	161
56CB4NGY	192	56SW120LERO	189	E32D20NGEWE	166	GBG02P	149	GE884S	161
56CB4NRO	192	56SW132LEGY	189	E32WE	168	GBG03	18	GEBAT	156
56E1GY	193	56SW220COLEGY	191	E332SAWE	165	GBG03	73	GEP1512TMC	138
56E1RO	193	56SW220LEGY	190	E33WE	168	GBG03	73	GEP1512TPC	138
56E2GY	193	56SW220LERO	190	E34061MWE	167	GBG03	92	GEP1512WMC	137
56E2RO	193	56SW232LEGY	190	E342SAWE	165	GBG03	92	GEP1512WPC	137
56E3GY	193	56SW232LERO	190	E34WE	168	GBG03	114	GEP1513WMC	137
56E3RO	193	56SW310LEGY	190	E35WE	168	GBG03	149	GEP1513WPC	137
56E4GY	194	56SW320LEGY	190	E426WE	164	GBG03	149	GEP1514WMC	137
56E4RO	194	56SW320LERO	190	E501SSWE	157	GBG03	45	GEP1514WPC	137
56E4VHGY	194	56SW332LEGY	190	E551SS	176	GBG03	45	GEP1522TMC	138
56E6GY	194	56SW332LERO	190	E551US	176	GBG03	45	GEP1522TPC	138
56E6RO	194	56SW350LEGY	190	E5522S	177	GBG04F	18	GEP1522WMC	137
						GBG04F	73		

# Index

Reference	PG	Reference	PG	Reference	PG	Reference	PG	Reference	PG
GEP1522WPC	137	GGBL01G	114	GGBL2033	110	GGBL6012V4S	109	GGBL9225	117
GEP1532WMC	137	GGBL02G	114	GGBL2033S	110	GGBL6022CS	109	GGBL9225S	117
GEP1532WPC	137	GGBL03G	114	GGBL20DPCHW	115	GGBL6022LS	109	GGBL9247	117
GEP1542WMC	137	GGBL04G	114	GGBL20DPDWW	115	GGBL6022V4S	109	GGBL9247S	117
GEP1542WPC	137	GGBL06G	114	GGBL20DPEFW	115	GGBL6032CS	109	GGBL9D25	117
GEP2510WMC	138	GGBL08G	114	GGBL20DPFAW	115	GGBL6032V4S	109	GGBL9D25S	117
GEP2510WPC	138	GGBL1011	107	GGBL20DPFFZW	115	GGBL6042CS	109	GGBLBW	115
GEP2511WMC	138	GGBL1011S	107	GGBL20DPFRW	115	GGBL6042V4S	109	GGBLC1GS	113
GEP2511WPC	138	GGBL1012	107	GGBL20DPFZW	115	GGBL70042	112	GGBLE7004	115
GEP3510WMC	136	GGBL1012116AS	108	GGBL20DPHOW	115	GGBL70042S	112	GGBLE7004S	115
GEP3510WPC	136	GGBL1012A	108	GGBL20DPHTW	115	GGBL7010	112	GGBLH1GS	113
GEP3520WMC	136	GGBL1012ARP	108	GGBL20DPMWW	115	GGBL7010S	112	GGBLILL	113
GEP3520WPC	136	GGBL1012AS	108	GGBL20DPOVW	115	GGBL7030	112	GGBLILLS	113
GEP3550WMC	136	GGBL1012R	107	GGBL20DPTDW	115	GGBL7030S	112	GGBLINDWG	116
GEP3560WMC	136	GGBL1012RB	107	GGBL20DPW	114	GGBL7051	112	GGBLINDWO	116
GEP3580WMC	136	GGBL1012RBS	107	GGBL20DPWMW	115	GGBL7051S	112	GGBLINDWR	116
GEP3580WPC	136	GGBL1012RP	107	GGBL3010	106	GGBL7061	112	GGBLSHF2GS	113
GEP4501WMC	139	GGBL1012RPS	107	GGBL3010D	106	GGBL7061S	112	GGBLSIND	114
GEP4501WPC	139	GGBL1012RS	107	GGBL3010DS	106	GGBL7062	112	GGBLSPC1	113
GEP5020WMC	139	GGBL1012S	107	GGBL3010S	106	GGBL7062S	112	GGBLSPC1FO	113
GEP5020WPC	139	GGBL1012W	108	GGBL3016A1	107	GGBL7071C5	112	GGBLSPC1S	113
GEP5021WMC	139	GGBL1012WS	108	GGBL3020	106	GGBL7071C5S	112	GGBLSPC2	113
GEP5021WPC	139	GGBL1013	108	GGBL30201USBS	107	GGBL7071C6	112	GGBLSPC2S	113
GEP5500WMC	139	GGBL10131L	108	GGBL3020D	106	GGBL7071C6S	112	GGBLTOP13ANS	106
GEP5500WPC	139	GGBL10131R	108	GGBL3020D4MP	113	GGBL7072C5	112	GGBSB4722M	30
GEP5501WMC	139	GGBL1014	107	GGBL3020DS	106	GGBL7072C5S	112	GGBSB4722M	60
GEP5501WPC	139	GGBL1014S	107	GGBL3020S	106	GGBL7072C6	112	GGBSB4724M	30
GEP5510WMC	139	GGBL1014W	108	GGBL30212DS	106	GGBL7072C6S	112	GGBSB4724M	60
GEP5510WPC	139	GGBL1014WS	108	GGBL3030	106	GGBL7074	113	GGGBL1013	108
GEP5511WMC	139	GGBL1022	107	GGBL3030S	106	GGBL707445510	113	GGGBL1013S	108
GEP5511WPC	139	GGBL1022A	108	GGBL3050	106	GGBL707445510S	113	GGGBL7020	112
GEP6512MC	138	GGBL1022S	107	GGBL3050NS	106	GGBL707445511	113	GGGBL7020S	112
GEP6512PC	138	GGBL1022W	108	GGBL3050S	106	GGBL707445511S	113	GJB20A	158
GEP6522MC	138	GGBL1022WS	108	GGBL3060	106	GGBL70746110	113	GJB20ABR	158
GEP6522PC	138	GGBL102RW	115	GGBL3060L	106	GGBL70746110S	113	GJB30A	158
GEP7510WMC	140	GGBL102W	114	GGBL3060S	106	GGBL7074S	113	GJB30ABR	158
GEP7510WPC	140	GGBL1032	107	GGBL3070	107	GGBL7081	113	GJB5A	158
GEP7521MC	140	GGBL1032S	107	GGBL3080	107	GGBL7081456	113	GJB5ABR	158
GEP7521PC	140	GGBL1032W	108	GGBL3081	107	GGBL7081456S	113	GJB620A	158
GEP7561WMC	140	GGBL1032WS	108	GGBL3090	107	GGBL7081S	113	GJB620ABR	158
GEP7561WPC	140	GGBL1042	108	GGBL3090S	107	GGBL7090S	111	GJBN20A	158
GEP7562WMC	140	GGBL1042S	108	GGBL4001	111	GGBL8010	114	GJBN20ABR	158
GEP7562WPC	140	GGBL10IW	114	GGBL4001S	111	GGBL8010S	114	GJBN20AS	158
GEP7581MC	140	GGBL13FCUWPW	115	GGBL4011	111	GGBL8020	114	GJBN20ASBR	158
GEP7590WMC	140	GGBL2010	109	GGBL4011S	111	GGBL8020S	114	GLHC	157
GEP7590WPC	140	GGBL2010HT	109	GGBL4031	110	GGBL8050	116	GMC1012	145
GEP8510MC	141	GGBL2010LS	109	GGBL4050	111	GGBL8060	116	GMC1022	146
GEP8510PC	141	GGBL2010OV	109	GGBL4050S	111	GGBL8080	116	GMC1032	146
GEP8520MC	141	GGBL2011	110	GGBL5000	110	GGBL9116	117	GMC131S	144
GEP8520PC	141	GGBL2011	114	GGBL5000S	110	GGBL9116A	117	GMC131SS	144
GESPEN613	156	GGBL2011S	110	GGBL5010	110	GGBL9116S	117	GMC132S	144
GESPEN618	156	GGBL2014WH	110	GGBL5011	110	GGBL9125	117	GMC132SS	144
GEURO1	130	GGBL201W	114	GGBL5013S	110	GGBL9125S	117	GMC13SP	146
GEURO2	130	GGBL2020W	115	GGBL6011CS	109	GGBL9147	117	GMC13SPF	147
GEURO4	130	GGBL2020CW	115	GGBL6012CS	109	GGBL9147S	117	GMC13SPN	146
GFOPLATE	127	GGBL202W	114	GGBL6012LS	109	GGBL9216A	117	GMC13SPNF	147

# Index

Reference	PG	Reference	PG	Reference	PG	Reference	PG	Reference	PG
GMC13SSP	147	GPAT3G25	131	GSW4G2W	125	GSWTPS	125	GU1222*SS	61
GMC13SSPF	147	GPATDG25	131	GSWA1G2W	125	GTELMAS	129	GU1222BBN	61
GMC13SSPN	147	GPEND62	156	GSWA2G2W	125	GTELRJ11	129	GU1222TBN	62
GMC13SSPNF	147	GPEND6C2	156	GSWDP20A	126	GTELRJ45	129	GU1222TPB	62
GMC20S	146	GPEND92	156	GSWDP20AFO	126	GTELSEC	129	GU1222TPC	62
GMC20SN	146	GPEND9C2	156	GSWDP20AFOAC	126	GU1011	11	GU1222TPN	62
GMC50S	148	GPRCDFCU	128	GSWDP20AFOHT	126	GU1012	11	GU1222TPW	62
GMC50S	148	GPRCDSKT1G	124	GSWDP20AFOTR	126	GU1012A	12	GU1222TSS	62
GMC50S2N	148	GPRCDSKT2G	124	GSWDP20AHT	126	GU1012GY	11	GU1222WPN	61
GMC50S2N	148	GPULLGY	12	GSWDP20AOV	126	GU1012R	11	GU1232*PB	61
GMC50SN	148	GPULLRD	12	GSWDPN20A	126	GU1012RB	11	GU1232*PC	61
GMC50SN	148	GRGYWF01	12	GSWDPN20AFO	126	GU1012RGY	11	GU1232*PW	61
GMC51S	144	GRGYWF01	12	GSWDPN20AFOAC	126	GU1012RP	11	GU1232*SS	61
GMCB1	148	GRL13FCUPW	178	GSWDPN20AFOHT	126	GU1013	12	GU1232BBN	61
GMCB1	148	GRL2020PW	178	GSWDPN20AFOTR	126	GU1014	11	GU1232TBN	63
GMCB2	148	GRL202KPW	178	GSWDPN20AFOWH	126	GU1014GY	11	GU1232TPB	63
GMCB2	148	GRL20DPNPW	178	GSWDPN20AHT	126	GU1022	11	GU1232TPC	63
GMCINT	145	GRLCOPW	178	GSWDPN20AOV	126	GU1022A	12	GU1232TPN	63
GMCPRCDFCU	147	GRLDPKPW	178	GSWINT	125	GU1022GY	11	GU1232TPW	63
GMCPRCDSKT1G	145	GRLINDRPW	178	GSWISO2	125	GU1032	11	GU1232TSS	63
GMCPRCDSKT2G	145	GRO	157	GSWNSPUR	128	GU1032GY	11	GU1232WPN	61
GMCS1012	145	GROC	157	GSWNSPURBO	128	GU1042	11	GU1242*PB	62
GMCS1022	146	GRWH1012	12	GSWNSPURCH	128	GU1062	11	GU1242*PC	62
GMCS1032	146	GRWH1012GY	12	GSWNSPURDW	128	GU1212*PB	61	GU1242*PW	62
GMCS131S	144	GRWH1014	12	GSWNSPUREF	128	GU1212*PC	61	GU1242*SS	62
GMCS131SS	144	GRWH1014GY	12	GSWNSPURFA	128	GU1212*PW	61	GU1242BBN	62
GMCS132S	144	GRWH1022	12	GSWNSPURFFZ	128	GU1212*SS	61	GU1242TBN	63
GMCS132SS	144	GRWH1022GY	12	GSWNSPURFR	128	GU1212BBN	61	GU1242TPB	63
GMCS133SP	146	GRWH1032A	12	GSWNSPURFZ	128	GU1212R*PB	61	GU1242TPC	63
GMCS133SPF	147	GRWH1032GY	12	GSWNSPURHO	128	GU1212R*PC	61	GU1242TPN	63
GMCS133PN	146	GSFOPLATE	127	GSWNSPURHT	128	GU1212R*PW	61	GU1242TPW	63
GMCS133PNF	147	GSHVSKT	129	GSWNSPURMW	128	GU1212R*SS	61	GU1242TSS	63
GMCS13SSP	147	GSKT15A1G	124	GSWNSPURTD	128	GU1212RBBN	61	GU1242WPN	62
GMCS13SSPF	147	GSKT1G	124	GSWNSPURWD	128	GU1212RWPN	61	GU1262*PB	62
GMCS13SSPN	147	GSKT2A1G	124	GSWNSPURWDY	128	GU1212TBN	62	GU1262*PC	62
GMCS13SSPNF	147	GSKT2G	124	GSWNSPURWM	128	GU1212TPB	62	GU1262*PW	62
GMCS20S	146	GSKT5A1G	124	GSWPULL50	157	GU1212TPC	62	GU1262*SS	62
GMCS20SN	146	GSKTCOAX	129	GSWPULL50N	157	GU1212TPN	62	GU1262BBN	62
GMCS50S	148	GSKTCOAX2G	129	GSWPULL6	157	GU1212TPW	62	GU1262WPN	62
GMCS50S2N	148	GSKTSW15A1G	124	GSWPULL62	157	GU1212TSS	62	GU1400F	31
GMCS50SN	148	GSKTSW1G	124	GSWSPUR	127	GU1212WPN	61	GU1412*PB	31
GMCS51S	144	GSKTSW2G2	124	GSWSPURBO	127	GU1213*PB	62	GU1412*PC	31
GMCSB1	148	GSKTSW3G	124	GSWSPURCH	127	GU1213*PC	62	GU1412*SS	31
GMCSB2	148	GSKTSWDP1G	124	GSWSPURDW	127	GU1213*PW	62	GU1412BBK	31
GMCSINT	145	GSKTSWDP1G2G	124	GSWSPUREF	127	GU1213*SS	62	GU1412BBN	31
GNSPUR	127	GSKTSWDP2G	124	GSWSPURFA	127	GU1213BBN	62	GU1412CLR	31
GPAT1G16	131	GSKTSWDP2G2G	124	GSWSPURFFZ	127	GU1213WPN	62	GU1412K*PB	34
GPAT1G16A	22	GSPUR	127	GSWSPURFR	127	GU1214*PB	61	GU1412K*PC	34
GPAT1G16A	131	GSPUR3A	127	GSWSPURFZ	127	GU1214*PC	61	GU1412K*SS	34
GPAT1G25	131	GSW1G1W	125	GSWSPURHO	127	GU1214*PW	61	GU1412KBBN	34
GPAT1G47	131	GSW1G2W	125	GSWSPURHT	127	GU1214*SS	61	GU1412KWPN	34
GPAT2G16A	22	GSW1G2WR	125	GSWSPURMW	127	GU1214BBN	61	GU1412KWPN	34
GPAT2G16A	131	GSW1G2WRB	125	GSWSPURTD	127	GU1214WPN	61	GU1412R*PB	31
GPAT2G25	131	GSW1G2WRP	125	GSWSPURWD	127	GU1222*PB	61	GU1412R*PC	31
GPAT2G47	131	GSW2G2W	125	GSWSPURWDY	127	GU1222*PC	61	GU1412R*SS	31
GPAT2GC25	131	GSW3G2W	125	GSWSPURWM	127	GU1222*PW	61	GU1412RBBN	31



# Index

Reference	PG	Reference	PG	Reference	PG	Reference	PG	Reference	PG
GU1412RWPN	31	GU1432TPW	34	GU2211*PB	66	GU2414WPW	38	GU3220D*PC	59
GU1412RWPW	31	GU1432TSS	34	GU2211*PC	66	GU2511*BC	88	GU3220D*SS	59
GU1412TBN	33	GU1432WPN	32	GU2211*SS	66	GU2511*PC	88	GU3220DBBN	59
GU1412TCLR	33	GU1432WPN	32	GU2211BBN	66	GU2513*BC	88	GU3220DWPW	59
GU1412TPB	33	GU1442*PB	32	GU2211WPN	66	GU2513*PC	88	GU3220DWPW	59
GU1412TPC	33	GU1442*PC	32	GU2211WPW	66	GU3010	10	GU3220WPN	58
GU1412TPN	33	GU1442*SS	32	GU2213*PB	66	GU3010D	10	GU3220WPN	58
GU1412TPW	33	GU1442BBN	32	GU2213*PC	66	GU3010DGY	10	GU3231*PC	59
GU1412TSS	33	GU1442TBN	34	GU2213*SS	66	GU3010DRD	10	GU3231*SS	59
GU1412WPN	31	GU1442TPB	34	GU2213BBN	66	GU3011	10	GU3231BBN	59
GU1412WPN	31	GU1442TPC	34	GU2213WPN	66	GU3020	10	GU3231WPN	59
GU1412WPN	31	GU1442TPN	34	GU2213WPW	66	GU3020D	10	GU3234*SS	59
GU1413*PB	32	GU1442TPW	34	GU2214*PB	66	GU3021	10	GU3234WPC	59
GU1413*PC	32	GU1442TSS	34	GU2214*PC	66	GU3030	10	GU3250*PB	58
GU1413*SS	32	GU1442WPN	32	GU2214*SS	66	GU3030GY	10	GU3250*PC	58
GU1413BBK	32	GU1442WPW	32	GU2214BBN	66	GU3030RD	10	GU3250*SS	58
GU1413BBN	32	GU1462*PB	32	GU2214WH*PB	66	GU3031	10	GU3250BBN	58
GU1413WPN	32	GU1462*PC	32	GU2214WH*PC	66	GU3032	10	GU3250WPN	58
GU1413WPW	32	GU1462*SS	32	GU2214WH*SS	66	GU3033	10	GU3250WPW	58
GU1414*PB	31	GU1462BBN	32	GU2214WHBBN	66	GU3034	10	GU3251*PB	59
GU1414*PC	31	GU1462WPN	32	GU2214WHWPN	66	GU3050	10	GU3251*PC	59
GU1414*SS	31	GU1462WPW	32	GU2214WHWPW	66	GU3060	10	GU3251*SS	59
GU1414BBN	31	GU1512*BC	86	GU2214WPN	66	GU3060RD	10	GU3251BBN	59
GU1414TBN	33	GU1512*PC	86	GU2214WPW	66	GU3070	11	GU3251WPN	59
GU1414TPB	33	GU1513*BC	87	GU2410*PB	37	GU3080	11	GU3251WPW	59
GU1414TPC	33	GU1513*PC	87	GU2410*PC	37	GU3090	11	GU3252*PB	59
GU1414TPN	33	GU1514*BC	86	GU2410*SS	37	GU3091	11	GU3252*PC	59
GU1414TPW	33	GU1514*PC	86	GU2410BBN	37	GU3210*PB	58	GU3252*SS	59
GU1414TSS	33	GU1522*BC	86	GU2410CLR	37	GU3210*PC	58	GU3252BBN	59
GU1414WPN	31	GU1522*PC	86	GU2410WPN	37	GU3210*SS	58	GU3252WPN	59
GU1414WPW	31	GU1532*BC	87	GU2410WPW	37	GU3210BBN	58	GU3252WPW	59
GU1422*PB	31	GU1532*PC	87	GU2411*PB	37	GU3210D*PB	58	GU3260*PB	58
GU1422*PC	31	GU1542*BC	87	GU2411*PC	37	GU3210D*PC	58	GU3260*PC	58
GU1422*SS	31	GU1542*PC	87	GU2411*SS	37	GU3210D*SS	58	GU3260*SS	58
GU1422BBK	31	GU2003	14	GU2411BBK	37	GU3210DBBN	58	GU3260BBN	58
GU1422BBN	31	GU2010	13	GU2411BBN	37	GU3210DWPW	58	GU3260WPN	58
GU1422CLR	31	GU2010GY	13	GU2411WPN	37	GU3210DWPW	58	GU3260WPW	58
GU1422CLR	32	GU2010HT	13	GU2411WPW	37	GU3210WPN	58	GU3270*PB	60
GU1422TBN	33	GU2010OV	13	GU2411WWH	37	GU3210WPW	58	GU3270*PC	60
GU1422TCLR	33	GU2011	13	GU2413*PB	37	GU3220*PB	58	GU3270*PW	60
GU1422TPB	33	GU2011HT	13	GU2413*PC	37	GU3220*PC	58	GU3270*SS	60
GU1422TPC	33	GU2011OV	13	GU2413*SS	37	GU3220*SS	58	GU3270BBN	60
GU1422TPN	33	GU2011TR	13	GU2413BBN	37	GU32202DMP*PB	60	GU3270WPN	60
GU1422TPW	33	GU2013	13	GU2413WPN	37	GU32202DMP*PC	60	GU3280*PB	60
GU1422TSS	33	GU2013HT	13	GU2413WPW	37	GU32202DMP*SS	60	GU3280*PC	60
GU1422WPN	31	GU2013TR	13	GU2414*PB	38	GU32202DMPBBN	60	GU3280*PW	60
GU1422WPW	31	GU2014	13	GU2414*PC	38	GU32202DMPWPW	60	GU3280*SS	60
GU1422WWH	31	GU2014HT	13	GU2414*SS	38	GU32204DMP*PB	60	GU3280BBN	60
GU1432*PB	32	GU2014WH	13	GU2414BBN	38	GU32204DMP*PC	60	GU3280WPN	60
GU1432*PC	32	GU2033	14	GU2414WH*PB	38	GU32204DMP*PC	60	GU3290*PB	60
GU1432*SS	32	GU2210*PB	66	GU2414WH*PC	38	GU32204DMP*SS	60	GU3290*PC	60
GU1432BBN	32	GU2210*PC	66	GU2414WH*SS	38	GU32204DMPBBN	60	GU3290*PW	60
GU1432TBN	34	GU2210*SS	66	GU2414WHBBN	38	GU32204DMPWPW	60	GU3290*SS	60
GU1432TPB	34	GU2210BBN	66	GU2414WHWPN	38	GU32204DMPWPW	60	GU3290BBN	60
GU1432TPC	34	GU2210WPN	66	GU2414WHWPW	38	GU3220BBN	58	GU3290WPN	60
GU1432TPN	34	GU2210WPW	66	GU2414WPN	38	GU3220D*PB	59	GU3410*PB	28

# Index

Reference	PG	Reference	PG	Reference	PG	Reference	PG	Reference	PG
GU3410*PC	28	GU3431WWH	29	GU4201*PC	68	GU5010BO	15	GU5211WPN	67
GU3410*SS	28	GU3434*SS	29	GU4201*SS	68	GU5010CH	15	GU5211WPW	67
GU3410BBN	28	GU3434WPC	29	GU4201BBN	68	GU5010DW	15	GU5213*PB	67
GU3410CLR	28	GU3450*PB	28	GU4201WPN	68	GU5010EF	15	GU5213*PC	67
GU3410D*PB	28	GU3450*PC	28	GU4201WPW	68	GU5010FA	15	GU5213*SS	67
GU3410D*PC	28	GU3450*SS	28	GU4221*PB	68	GU5010FFZ	15	GU5213BBN	67
GU3410D*SS	28	GU3450BBN	28	GU4221*PC	68	GU5010FR	15	GU5213WPN	67
GU3410DBBK	28	GU3450WPN	28	GU4221*SS	68	GU5010FZ	15	GU5213WPW	67
GU3410DBBN	28	GU3450WPW	28	GU4221BBN	68	GU5010GY	15	GU5214*PB	68
GU3410DWPW	28	GU3460*PB	28	GU4221WPN	68	GU5010HO	15	GU5214*PC	68
GU3410DWPW	28	GU3460*PC	28	GU4221WPW	68	GU5010HT	15	GU5214*SS	68
GU3410DWWH	28	GU3460*SS	28	GU4231*PB	66	GU5010MW	15	GU5214BBN	68
GU3410WPN	28	GU3460BBN	28	GU4231*PC	66	GU5010RD	15	GU5214WPN	68
GU3410WPW	28	GU3460WPN	28	GU4231*SS	66	GU5010TD	15	GU5214WPW	68
GU3411D*PB	29	GU3460WPW	28	GU4231BBN	66	GU5010WD	15	GU5400*PB	38
GU3411D*PC	29	GU3470*PB	30	GU4231WPN	66	GU5010WM	15	GU5400*PC	38
GU3411D*SS	29	GU3470*PC	30	GU4231WPW	66	GU5011	15	GU5400*SS	38
GU3411DBBN	29	GU3470*SS	30	GU4401*PB	40	GU5011BO	15	GU5400BBN	38
GU3411DWPW	29	GU3470BBN	30	GU4401*PC	40	GU5011CH	15	GU5400WPN	38
GU3411DWPW	29	GU3470WPN	30	GU4401*SS	40	GU5011DW	15	GU5400WPW	38
GU3420*PB	29	GU3470WPW	30	GU4401BBK	40	GU5011EF	15	GU5403*PB	38
GU3420*PC	29	GU3480*PB	30	GU4401BBN	40	GU5011FA	15	GU5403*PC	38
GU3420*SS	29	GU3480*PC	30	GU4401WPN	40	GU5011FFZ	15	GU5403*SS	38
GU34202DMP*PB	30	GU3480*SS	30	GU4401WPW	40	GU5011FR	15	GU5403BBN	38
GU34202DMP*PC	30	GU3480BBN	30	GU4401WWH	40	GU5011FZ	15	GU5403WPN	38
GU34202DMP*SS	30	GU3480WPN	30	GU4421*PB	40	GU5011GY	15	GU5403WPW	38
GU34202DMPBBN	30	GU3480WPW	30	GU4421*PC	40	GU5011HO	15	GU5410*PB	39
GU34202DMPWPN	30	GU3480WWH	30	GU4421*SS	40	GU5011HT	15	GU5410*PC	39
GU34202DMPWPW	30	GU3490*PB	30	GU4421BBN	40	GU5011MW	15	GU5410*SS	39
GU34204DMP*PB	30	GU3490*PC	30	GU4421WPN	40	GU5011TD	15	GU5410BBN	39
GU34204DMP*PC	30	GU3490*SS	30	GU4421WPW	40	GU5011WD	15	GU5410CLR	39
GU34204DMP*SS	30	GU3490BBN	30	GU4431*PB	38	GU5011WM	15	GU5410WPN	39
GU34204DMPBBN	30	GU3490WPN	30	GU4431*PC	38	GU5013	15	GU5410WPW	39
GU34204DMPWPN	30	GU3490WPW	30	GU4431*SS	38	GU5014	15	GU5411*PB	39
GU34204DMPWPW	30	GU3510*BC	86	GU4431BBN	38	GU5200*PB	67	GU5411*PC	39
GU3420BBN	29	GU3510*PC	86	GU4431WPN	38	GU5200*PC	67	GU5411*SS	39
GU3420CLR	29	GU3520*BC	86	GU4431WPW	38	GU5200*SS	67	GU5411BBK	39
GU3420D*PB	29	GU3520*PC	86	GU4501*BC	89	GU5200BBN	67	GU5411BBN	39
GU3420D*PC	29	GU3530*BC	86	GU4501*PC	89	GU5200WPN	67	GU5411WPN	39
GU3420D*SS	29	GU3530*BC	86	GU4521*PC	89	GU5200WPW	67	GU5411WPW	39
GU3420DBBK	29	GU3530*PC	86	GU4521*PC	89	GU5203*PB	67	GU5411WWH	39
GU3420DBBN	29	GU3530*PC	86	GU5000	14	GU5203*PC	67	GU5413*PB	39
GU3420DWPW	29	GU3631GMC	144	GU50003	14	GU5203*SS	67	GU5413*PC	39
GU3420DWPW	29	GU4000	16	GU5000HT	14	GU5203BBN	67	GU5413*SS	39
GU3420DWWH	29	GU4000GY	16	GU5000MW	14	GU5203WPN	67	GU5413BBN	39
GU3420WPN	29	GU4001	16	GU5000RD	14	GU5203WPW	67	GU5413WPN	39
GU3420WPW	29	GU4010	16	GU5000SS	14	GU5210*PB	67	GU5413WPW	39
GU3421D*PB	29	GU4011	16	GU5000TD	14	GU5210*PC	67	GU5414*PB	39
GU3421D*PC	29	GU4020	16	GU5000TR	14	GU5210*SS	67	GU5414*PC	39
GU3421D*SS	29	GU4020GY	16	GU5000WD	14	GU5210BBN	67	GU5414*SS	39
GU3421DBBK	29	GU4021	16	GU5001	14	GU5210WPN	67	GU5414BBN	39
GU3421DWPW	29	GU4021	111	GU5003	14	GU5210WPW	67	GU5414WPN	39
GU3421DWPW	29	GU4021S	111	GU50033	14	GU5211*PB	67	GU5414WPW	39
GU3431*PC	29	GU4031	14	GU5003TR	14	GU5211*PC	67	GU5500*BC	88
GU3431*SS	29	GU4050	16	GU5004	14	GU5211*SS	67	GU5500*PC	88
GU3431WPW	29	GU4201*PB	68	GU5010	15	GU5211BBN	67	GU5510*BC	88

# Index

Reference	PG	Reference	PG	Reference	PG	Reference	PG	Reference	PG
GU5510*PC	88	GU6222LPC	64	GU6422CPW	35	GU7090	16	GU7420*PC	42
GU5511*BC	88	GU6222LPN	64	GU6422CSS	35	GU7090GY	16	GU7420*SS	42
GU5511*PC	88	GU6222LPW	64	GU6422E*PB	36	GU7210*PB	70	GU7420BBN	42
GU5514*BC	88	GU6222LSS	64	GU6422E*PC	36	GU7210*PC	70	GU7420BBN	42
GU5514*PC	88	GU6232CBN	64	GU6422E*SS	36	GU7210*SS	70	GU7420WPW	42
GU6000RC1	37	GU6232CPB	64	GU6422EBBN	36	GU7210BBN	70	GU7420WPW	42
GU6000RC1	52	GU6232CPC	64	GU6422EWPW	36	GU7210WPW	70	GU7430*PB	42
GU6000RC1	80	GU6232CPN	64	GU6422EWPW	36	GU7210WPW	70	GU7430*PC	42
GU6000RC1	97	GU6232CPW	64	GU6422LBN	36	GU7220*PB	70	GU7430*SS	42
GU6000RC1	65	GU6232CSS	64	GU6422LPB	36	GU7220*PC	70	GU7430BBN	42
GU6012C	13	GU6232LBN	64	GU6422LPC	36	GU7220*SS	70	GU7430WPW	42
GU6012L	13	GU6232LPB	64	GU6422LPN	36	GU7220BBN	70	GU7430WPW	42
GU6022C	13	GU6232LPC	64	GU6422LPW	36	GU7220WPW	70	GU7451*PB	41
GU6022L	13	GU6232LPN	64	GU6422LSS	36	GU7220WPW	70	GU7451*PC	41
GU6032C	13	GU6232LPW	64	GU6432CBN	35	GU7230*PB	70	GU7451*SS	41
GU6032L	13	GU6232LSS	64	GU6432CPB	35	GU7230*PC	70	GU7451BBN	41
GU6042C	13	GU6242CBN	64	GU6432CPC	35	GU7230*SS	70	GU7451WPW	41
GU6042L	13	GU6242CPB	64	GU6432CPN	35	GU7230BBN	70	GU7451WPW	41
GU6212CBN	63	GU6242CPC	64	GU6432CPW	35	GU7230WPW	70	GU7461*PB	41
GU6212CPB	63	GU6242CPN	64	GU6432CSS	35	GU7230WPW	70	GU7461*PC	41
GU6212CPC	63	GU6242CPW	64	GU6432LBN	36	GU7251*PB	69	GU7461*SS	41
GU6212CPN	63	GU6242CSS	64	GU6432LPB	36	GU7251*PC	69	GU7461BBK	41
GU6212CPW	63	GU6242LBN	65	GU6432LPC	36	GU7251*SS	69	GU7461BBN	41
GU6212CSS	63	GU6242LPB	65	GU6432LPN	36	GU7251BBN	69	GU7461WPW	41
GU6212E*PB	65	GU6242LPC	65	GU6432LPW	36	GU7251WPW	69	GU7461WPW	41
GU6212E*PC	65	GU6242LPN	65	GU6432LSS	36	GU7251WPW	69	GU7461WWH	41
GU6212E*SS	65	GU6242LPW	65	GU6442CBN	35	GU7261*PB	69	GU7462*PB	41
GU6212EBBN	65	GU6242LSS	65	GU6442CPB	35	GU7261*PC	69	GU7462*PC	41
GU6212EWPW	65	GU6412CBN	35	GU6442CPC	35	GU7261*SS	69	GU7462*SS	41
GU6212EWPW	65	GU6412CPB	35	GU6442CPN	35	GU7261BBN	69	GU7462BBK	41
GU6212LBN	64	GU6412CPC	35	GU6442CPW	35	GU7261WPW	69	GU7462BBN	41
GU6212LPB	64	GU6412CPN	35	GU6442CSS	35	GU7261WPW	69	GU7462WPW	41
GU6212LPC	64	GU6412CPW	35	GU6442LBN	36	GU7262*PB	69	GU7462WPW	41
GU6212LPN	64	GU6412CSS	35	GU6442LPB	36	GU7262*PC	69	GU7462WWH	41
GU6212LPW	64	GU6412E*PB	36	GU6442LPC	36	GU7262*SS	69	GU7471*PB	41
GU6212LSS	64	GU6412E*PC	36	GU6442LPN	36	GU7262BBN	69	GU7471*PC	41
GU6212R*PB	65	GU6412E*SS	36	GU6442LPW	36	GU7262WPW	69	GU7471*SS	41
GU6212R*PC	65	GU6412EBBN	36	GU6442LSS	36	GU7262WPW	69	GU7471BBK	41
GU6212R*SS	65	GU6412EWPW	36	GU6512CBC	87	GU7271*PB	69	GU7471BBN	41
GU6212RBBN	65	GU6412EWPW	36	GU6512CPC	87	GU7271*PC	69	GU7471WPW	41
GU6212RWPN	65	GU6412LBN	35	GU6522CBC	87	GU7271*SS	69	GU7471WPW	41
GU6212RWPW	65	GU6412LPB	35	GU6522CPC	87	GU7271BBN	69	GU7471WWH	41
GU6222CBN	63	GU6412LPC	35	GU6532CBC	87	GU7271WPW	69	GU7490*PB	40
GU6222CPB	63	GU6412LPN	35	GU6532CPC	87	GU7271WPW	69	GU7490*PC	40
GU6222CPC	63	GU6412LPW	35	GU7010	17	GU7290*PB	68	GU7490*SS	40
GU6222CPN	63	GU6412LSS	35	GU7020	17	GU7290*PC	68	GU7490BBK	40
GU6222CPW	63	GU6412R*PB	37	GU7021	17	GU7290*SS	68	GU7490BBN	40
GU6222CSS	63	GU6412R*PC	37	GU7030	17	GU7290BBN	68	GU7490WPW	40
GU6222E*PB	65	GU6412R*SS	37	GU7040	17	GU7290WPW	68	GU7490WPW	40
GU6222E*PC	65	GU6412RBBN	37	GU7051	16	GU7290WPW	68	GU7490WWH	40
GU6222E*SS	65	GU6412RWPW	37	GU7061	16	GU7410*PB	42	GU7510*BC	90
GU6222EBBN	65	GU6412RWPW	37	GU7062	16	GU7410*PC	42	GU7510*PC	90
GU6222EWPW	65	GU6422CBN	35	GU7071	17	GU7410*SS	42	GU7561*BC	89
GU6222EWPW	65	GU6422CPB	35	GU7072	17	GU7410BBN	42	GU7561*PC	89
GU6222LBN	64	GU6422CPC	35	GU7074	17	GU7410WP	42	GU7562*BC	89
GU6222LPB	64	GU6422CPN	35	GU7081	17	GU7410WPW	42	GU7562*PC	89

# Index

Reference	PG	Reference	PG	Reference	PG	Reference	PG	Reference	PG
GU7590*BC	89	GU8450PW	42	GUE7012*	43	GUE7073*	91	GUG02GMC	149
GU7590*PC	89	GU8450SS	42	GUE7012*	71	GUE7073W	21	GUG02GMS	72
GU8010	17	GU8460BN	43	GUE7012*	91	GUE7073W	116	GUG02GPB	72
GU8020	17	GU8460PB	43	GUE7012W	21	GUE7073W	130	GUG02GPN	72
GU8050	21	GU8460PC	43	GUE7012W	116	GUE7074*	43	GUG02GPW	72
GU8050GY	21	GU8460PN	43	GUE7012W	130	GUE7074*	71	GUG02GSMC	149
GU8060	21	GU8460PW	43	GUE7020*	43	GUE7074*	91	GUG02GSS	72
GU8060GY	21	GU8460SS	43	GUE7020*	91	GUE7074W	21	GUG03G	18
GU8080	21	GU8480BN	43	GUE7020*	71	GUE7074W	116	GUG03GBN	73
GU8080GY	21	GU8480PB	43	GUE7020W	21	GUE7074W	130	GUG03GGY	18
GU8210BN	72	GU8480PC	43	GUE7020W	116	GUE7075*	43	GUG03GMC	149
GU8210PB	72	GU8480PN	43	GUE7020W	130	GUE7075*	91	GUG03GMC	149
GU8210PC	72	GU8480PW	43	GUE7030*	43	GUE7075*	71	GUG03GMS	73
GU8210PN	72	GU8480SS	43	GUE7030*	91	GUE7075W	21	GUG03GPB	73
GU8210PW	72	GU8510BC	91	GUE7030*	71	GUE7075W	116	GUG03GPN	73
GU8210SS	72	GU8510PC	91	GUE7030W	21	GUE7075W	130	GUG03GPW	73
GU8220BN	72	GU8520BC	91	GUE7030W	116	GUE7081*	43	GUG03GSMC	149
GU8220PB	72	GU8520PC	91	GUE7030W	130	GUE7081*	91	GUG03GSS	73
GU8220PC	72	GU8550BC	90	GUE7040*	43	GUE7081*	71	GUG04G	18
GU8220PN	72	GU8550PC	90	GUE7040*	91	GUE7081W	21	GUG04GBN	73
GU8220PW	72	GU8560BC	90	GUE7040*	71	GUE7081W	116	GUG04GGY	18
GU8220SS	72	GU8560PC	90	GUE7040W	21	GUE7081W	130	GUG04GMC	149
GU8250BN	70	GU8580BC	90	GUE7040W	116	GUE7082*	43	GUG04GMC	149
GU8250PB	70	GU8580PC	90	GUE7040W	130	GUE7082*	91	GUG04GMS	73
GU8250PC	70	GU9116	22	GUE7051*	43	GUE7082*	71	GUG04GPB	73
GU8250PN	70	GU9125	22	GUE7051*	71	GUE7082W	21	GUG04GPN	73
GU8250PW	70	GU9135	22	GUE7051*	91	GUE7082W	116	GUG04GPW	73
GU8250SS	70	GU9147	22	GUE7051W	21	GUE7082W	130	GUG04GSS	73
GU8260BN	70	GU9225	22	GUE7051W	116	GUE7091*	43	GUG06G	18
GU8260PB	70	GU9235	22	GUE7051W	130	GUE7091*	71	GUG06GBN	73
GU8260PC	70	GU9247	22	GUE7061*	71	GUE7091*	91	GUG06GGY	18
GU8260PN	70	GU9D25	22	GUE7061*	43	GUE7091W	21	GUG06GMC	149
GU8260PW	70	GUE7000*	43	GUE7061*	91	GUE7091W	116	GUG06GMC	149
GU8260SS	70	GUE7000*	91	GUE7061W	21	GUE7091W	130	GUG06GMS	73
GU8280BN	71	GUE7000*	71	GUE7061W	116	GUE8010*	43	GUG06GPB	73
GU8280PB	71	GUE7000W	21	GUE7061W	130	GUE8010*	71	GUG06GPN	73
GU8280PC	71	GUE7000W	116	GUE7062*	43	GUE8010*	91	GUG06GPW	73
GU8280PN	71	GUE7000W	130	GUE7062*	71	GUE8010W	21	GUG06GSMC	149
GU8280PW	71	GUE7001*	43	GUE7062*	91	GUE8010W	116	GUG06GSS	73
GU8280SS	71	GUE7001*	91	GUE7062W	21	GUE8010W	130	GUG08G	18
GU8410BN	44	GUE7001*	71	GUE7062W	116	GUG01G	18	GUG08GBN	73
GU8410PB	44	GUE7001W	21	GUE7062W	130	GUG01GBN	72	GUG08GGY	18
GU8410PC	44	GUE7001W	116	GUE7071*	43	GUG01GGY	18	GUG08GMC	149
GU8410PN	44	GUE7001W	130	GUE7071*	71	GUG01GMC	149	GUG08GMC	149
GU8410PW	44	GUE7010*	43	GUE7071*	91	GUG01GMC	149	GUG08GMS	73
GU8410SS	44	GUE7010*	91	GUE7071W	21	GUG01GMS	72	GUG08GPB	73
GU8420BN	44	GUE7010*	71	GUE7071W	116	GUG01GPB	72	GUG08GPN	73
GU8420PB	44	GUE7010W	21	GUE7071W	130	GUG01GPN	72	GUG08GPW	73
GU8420PC	44	GUE7010W	116	GUE7072*	43	GUG01GPW	72	GUG08GSMC	149
GU8420PN	44	GUE7010W	130	GUE7072*	71	GUG01GSMC	149	GUG08GSS	73
GU8420PW	44	GUE7011*	43	GUE7072*	91	GUG01GSMC	149	GUG09G	18
GU8420SS	44	GUE7011*	71	GUE7072W	21	GUG01GSS	72	GUG09GBN	73
GU8450BN	42	GUE7011*	91	GUE7072W	116	GUG02G	18	GUG09GMC	150
GU8450PB	42	GUE7011W	21	GUE7072W	130	GUG02GBN	72	GUG09GMS	73
GU8450PC	42	GUE7011W	116	GUE7073*	43	GUG02GGY	18	GUG09GPB	73
GU8450PN	42	GUE7011W	130	GUE7073*	71	GUG02GMC	149	GUG09GPN	73

# Index

Reference	PG	Reference	PG	Reference	PG	Reference	PG	Reference	PG
GUG09GPW	73	GUG10ITWPN	49	GUG18GPW	74	GUG202KELWPW	95	GUG20DPKBBN	50
GUG09GSMC	150	GUG10ITWPN	77	GUG18GSMC	150	GUG202KEPWPW	115	GUG20DPKBBN	78
GUG09GSS	73	GUG10ITWPW	49	GUG18GSS	74	GUG202KWPN	50	GUG20DPKBLK	95
GUG101M*	47	GUG10ITWPW	77	GUG201M*	47	GUG202KWPN	78	GUG20DPKELWPW	20
GUG101M*	75	GUG10ITWPW	95	GUG201M*	75	GUG202KWPPW	20	GUG20DPKELWPW	115
GUG101M*	93	GUG10IW	19	GUG201M*	93	GUG202KWPPW	50	GUG20DPKELWPW	152
GUG101W	19	GUG10IW	151	GUG201W	19	GUG202KWPPW	78	GUG20DPKWPN	50
GUG101W	151	GUG12G	18	GUG201W	151	GUG202KWPPW	95	GUG20DPKWPN	78
GUG102M*	47	GUG12GBN	74	GUG202*MS	48	GUG202KWPPW	152	GUG20DPKWPPW	20
GUG102M*	75	GUG12GMC	150	GUG202*MS	77	GUG202M*	47	GUG20DPKWPPW	50
GUG102M*	93	GUG12GMS	74	GUG202*MS	94	GUG202M*	75	GUG20DPKWPPW	78
GUG102R*MS	49	GUG12GPB	74	GUG202*PB	48	GUG202M*	93	GUG20DPKWPPW	95
GUG102R*MS	77	GUG12GPN	74	GUG202*PB	77	GUG202OC*MS	48	GUG20DPKWPPW	115
GUG102R*MS	94	GUG12GPW	74	GUG202*SS	48	GUG202OC*MS	77	GUG20DPKWPPW	152
GUG102R*PB	49	GUG12GSMC	150	GUG202*SS	77	GUG202OC*MS	94	GUG20DPM*	47
GUG102R*PB	77	GUG12GSS	74	GUG202BBN	48	GUG202OC*PB	48	GUG20DPM*	75
GUG102R*SS	49	GUG13FCU*MS	53	GUG202BBN	77	GUG202OC*PB	77	GUG20DPM*	93
GUG102R*SS	77	GUG13FCU*MS	81	GUG202BLK	94	GUG202OC*SS	48	GUG20DPMW	47
GUG102RBBN	49	GUG13FCU*MS	97	GUG202M*	47	GUG202OC*SS	77	GUG20DPMW	75
GUG102RBBN	77	GUG13FCU*PB	53	GUG202M*	75	GUG202OCBBN	48	GUG20DPMW	93
GUG102RBLK	94	GUG13FCU*PB	81	GUG202M*	93	GUG202OCBBN	77	GUG20DPMWW	19
GUG102RW	20	GUG13FCU*SS	53	GUG202MB	47	GUG202OCBLK	94	GUG20DPMWW	151
GUG102RW	151	GUG13FCU*SS	81	GUG202MB	75	GUG202OCW	20	GUG20DPOWW	19
GUG102RWPN	49	GUG13FCUBBN	53	GUG202MB	93	GUG202OCW	151	GUG20DPOWW	151
GUG102RWPN	77	GUG13FCUBBN	81	GUG202OW	20	GUG202OCWPN	48	GUG20DPTDW	19
GUG102RWPPW	49	GUG13FCUBLK	97	GUG202OW	151	GUG202OCWPN	77	GUG20DPTDW	151
GUG102RWPPW	77	GUG13FCUWPN	53	GUG202OWPN	48	GUG202OCWPPW	48	GUG20DPW	19
GUG102RWPPW	94	GUG13FCUWPN	81	GUG202OWPN	77	GUG202OCWPPW	77	GUG20DPW	151
GUG102T*MS	49	GUG13FCUWPN	20	GUG202OWPPW	48	GUG202OCWPPW	94	GUG20DPWDW	19
GUG102T*MS	77	GUG13FCUWPN	53	GUG202OWPPW	77	GUG202W	19	GUG20DPWDW	151
GUG102T*MS	95	GUG13FCUWPN	81	GUG202OWPPW	94	GUG202W	151	GUG20DPWDYW	19
GUG102T*PB	49	GUG13FCUWPN	97	GUG202K*MS	50	GUG202W	19	GUG20DPWDYW	151
GUG102T*PB	77	GUG13FCUWPN	152	GUG202K*MS	78	GUG202WPBOW	19	GUG20DPWMMW	19
GUG102T*SS	49	GUG16CO*MS	53	GUG202K*MS	95	GUG202WPBOW	151	GUG20DPWMMW	151
GUG102T*SS	77	GUG16CO*MS	81	GUG202K*PB	50	GUG202PCHW	19	GUG24G	19
GUG102TBBN	49	GUG16CO*MS	97	GUG202K*PB	78	GUG202PCHW	151	GUG24GBN	74
GUG102TBBN	77	GUG16CO*MS	53	GUG202K*SS	50	GUG202PDWW	19	GUG24GMC	150
GUG102TWPN	49	GUG16CO*PB	81	GUG202K*SS	78	GUG202PDWW	151	GUG24GMS	74
GUG102TWPN	77	GUG16CO*PB	53	GUG202K*SS	78	GUG202PEFW	19	GUG24GPB	74
GUG102TWPPW	49	GUG16CO*SS	53	GUG202KBBN	50	GUG202PEFW	151	GUG24GPN	74
GUG102TWPPW	77	GUG16CO*SS	81	GUG202KBBN	78	GUG202PFAW	19	GUG24GPW	74
GUG102TWPPW	95	GUG16COBBN	53	GUG202KBLK	95	GUG202PFAW	151	GUG24GSMC	150
GUG102W	19	GUG16COBBN	81	GUG202KEL*MS	50	GUG202PFFZW	19	GUG24GSS	74
GUG102W	151	GUG16COBLK	97	GUG202KEL*MS	78	GUG202PFFZW	151	GUGB*	53
GUG10IM*	47	GUG16COWPN	53	GUG202KEL*MS	95	GUG202PFRW	19	GUGB*	81
GUG10IM*	75	GUG16COWPN	81	GUG202KEL*PB	50	GUG202PFZW	19	GUGB*	53
GUG10IM*	93	GUG16COWPW	20	GUG202KEL*PB	78	GUG202PFZW	151	GUGB*MS	53
GUG10IT*MS	49	GUG16COWPW	53	GUG202KEL*PB	78	GUG202PHOW	19	GUGB*MS	81
GUG10IT*MS	77	GUG16COWPW	81	GUG202KEL*SS	50	GUG202PHOW	19	GUGB*MS	97
GUG10IT*MS	95	GUG16COWPW	97	GUG202KEL*SS	78	GUG202PHTW	19	GUGB*PB	53
GUG10IT*PB	49	GUG16COWPW	152	GUG202KELBBN	50	GUG202PHTW	151	GUGB*PB	81
GUG10IT*PB	77	GUG18G	19	GUG202KELBBN	78	GUG202PK*MS	50	GUGB*SS	53
GUG10IT*SS	49	GUG18GBN	74	GUG202KELBLK	95	GUG202PK*MS	78	GUGB*SS	81
GUG10IT*SS	77	GUG18GBN	74	GUG202KELWPW	50	GUG202PK*MS	95	GUGBBBN	53
GUG10ITBNN	49	GUG18GMC	150	GUG202KELWPW	78	GUG202PK*PB	50	GUGBBBN	81
GUG10ITBNN	77	GUG18GMS	74	GUG202KELWPW	20	GUG202PK*PB	78	GUGBBLK	97
		GUG18GPB	74	GUG202KELWPW	50	GUG202PK*SS	50	GUGBW	20
		GUG18GPN	74	GUG202KELWPW	78	GUG202PK*SS	78		

# Index

Reference	PG	Reference	PG	Reference	PG	Reference	PG	Reference	PG
GUGBW	151	GUGINDBG	54	GUGRBOPB	76	GUGREFPW	48	GUGRFZBLK	48
GUGBWP	53	GUGINDBG	82	GUGRBOPN	48	GUGREFPW	76	GUGRFZBLK	76
GUGBWP	81	GUGINDBG	98	GUGRBOPN	76	GUGREFPW	94	GUGRFZBLK	94
GUGBWPW	53	GUGINDBO	54	GUGRBOPW	48	GUGREFSS	48	GUGRFZBN	48
GUGBWPW	81	GUGINDBO	82	GUGRBOPW	76	GUGREFSS	76	GUGRFZBN	76
GUGBWPW*	97	GUGINDBO	98	GUGRBOPW	94	GUGRFABLK	48	GUGRFZMS	48
GUGCO*MS	52	GUGINDBR	54	GUGRBOSS	48	GUGRFABLK	76	GUGRFZMS	76
GUGCO*MS	80	GUGINDBR	82	GUGRBOSS	76	GUGRFABLK	94	GUGRFZMS	94
GUGCO*MS	96	GUGINDBR	98	GUGRCHBLK	48	GUGRFABN	48	GUGRFZPB	48
GUGCO*PB	52	GUGINDWG	20	GUGRCHBLK	76	GUGRFABN	76	GUGRFZPB	76
GUGCO*PB	80	GUGINDWG	54	GUGRCHBLK	94	GUGRFAMS	48	GUGRFZPN	48
GUGCO*SS	52	GUGINDWG	82	GUGRCHBN	48	GUGRFAMS	76	GUGRFZPN	76
GUGCO*SS	80	GUGINDWG	98	GUGRCHBN	76	GUGRFAMS	94	GUGRFZPW	48
GUGCOBBN	52	GUGINDWG	151	GUGRCHMS	48	GUGRFAPB	48	GUGRFZPW	76
GUGCOBBN	80	GUGINDWO	20	GUGRCHMS	76	GUGRFAPB	76	GUGRFZPW	94
GUGCOBLK	96	GUGINDWO	54	GUGRCHMS	94	GUGRFAPN	48	GUGRFZSS	48
GUGCOWPN	52	GUGINDWO	82	GUGRCHPB	48	GUGRFAPN	76	GUGRFZSS	76
GUGCOWPN	80	GUGINDWO	98	GUGRCHPB	76	GUGRFAPW	48	GUGRHEBLK	48
GUGCOWPW	20	GUGINDWO	151	GUGRCHPN	48	GUGRFAPW	76	GUGRHEBLK	76
GUGCOWPW	52	GUGINDWR	20	GUGRCHPN	76	GUGRFAPW	94	GUGRHEBLK	94
GUGCOWPW	80	GUGINDWR	54	GUGRCHPW	48	GUGRFASS	48	GUGRHEBN	48
GUGCOWPW	96	GUGINDWR	82	GUGRCHPW	76	GUGRFASS	76	GUGRHEBN	76
GUGCOWPW	152	GUGINDWR	98	GUGRCHPW	94	GUGRFRBLK	48	GUGRHEMS	48
GUGEMDIM*MS16	52	GUGINDWR	151	GUGRCHSS	48	GUGRFRBLK	76	GUGRHEMS	76
GUGEMDIM*MS16	80	GUGL01BC	92	GUGRCHSS	76	GUGRFRBLK	94	GUGRHEMS	94
GUGEMDIM*MS16	97	GUGL01MS	92	GUGRDWBLK	48	GUGRFRBN	48	GUGRHEPB	48
GUGEMDIM*PB16	52	GUGL02BC	92	GUGRDWBLK	76	GUGRFRBN	76	GUGRHEPB	76
GUGEMDIM*PB16	80	GUGL02MS	92	GUGRDWBLK	94	GUGRFRFZBLK	48	GUGRHEPN	48
GUGEMDIM*SS16	52	GUGL03BC	92	GUGRDWBN	48	GUGRFRFZBLK	76	GUGRHEPN	76
GUGEMDIM*SS16	80	GUGL03MS	92	GUGRDWBN	76	GUGRFRFZBLK	94	GUGRHEPW	48
GUGEMDIMB16	52	GUGL04BC	92	GUGRDWMS	48	GUGRFRFZBN	48	GUGRHEPW	76
GUGEMDIMB16	80	GUGL04MS	92	GUGRDWMS	76	GUGRFRFZBN	76	GUGRHEPW	94
GUGEMDIMBLK16	97	GUGL06BC	92	GUGRDWMS	94	GUGRFRFZMS	48	GUGRHESS	48
GUGEMDIMWPN16	52	GUGL06MS	92	GUGRDWPB	48	GUGRFRFZMS	76	GUGRHESS	76
GUGEMDIMWPN16	80	GUGL08BC	92	GUGRDWPB	76	GUGRFRFZMS	94	GUGRHOBK	48
GUGEMDIMWPN16	97	GUGL08MS	92	GUGRDWPB	94	GUGRFRFZMS	76	GUGRHOBK	76
GUGEMDIMWPN16	80	GUGRBLK	48	GUGRDWPN	48	GUGRFRFZPB	48	GUGRHOBK	94
GUGEMDIMWPN16	80	GUGRBLK	76	GUGRDWPN	76	GUGRFRFZPB	76	GUGRHOBK	76
GUGEMDIMWPN16	97	GUGRBLK	94	GUGRDWPN	94	GUGRFRFZPN	48	GUGRHOBK	94
GUGEMRDIMB16	52	GUGRBLK	48	GUGRDWPPW	48	GUGRFRFZPN	76	GUGRHOBN	48
GUGEMRDIMB16	80	GUGRBN	48	GUGRDWPPW	76	GUGRFRFZPN	94	GUGRHOBN	76
GUGEMRDIMB16	97	GUGRBN	76	GUGRDWSS	48	GUGRFRFZPW	48	GUGRHOBN	94
GUGEMRDIMW16	52	GUGRBOBLK	48	GUGRDWSS	76	GUGRFRFZPW	76	GUGRHOMS	48
GUGEMRDIMW16	80	GUGRBOBLK	48	GUGREFBLK	48	GUGRFRFZPW	94	GUGRHOMS	76
GUGEMRDIMW16	97	GUGRBOBLK	76	GUGREFBLK	76	GUGRFRFZSS	48	GUGRHOMS	94
GUGEMW*MS	53	GUGRBOBLK	76	GUGREFBLK	94	GUGRFRFZSS	76	GUGRHOPB	48
GUGEMW*MS	81	GUGRBOBLK	94	GUGREFBN	48	GUGRFRMS	48	GUGRHOPB	48
GUGEMW*PB	53	GUGRBOBLK	94	GUGREFBN	76	GUGRFRMS	76	GUGRHOPB	76
GUGEMW*PB	81	GUGRBOBN	48	GUGREFMS	48	GUGRFRMS	94	GUGRHOPN	48
GUGEMW*PB	81	GUGRBOBN	76	GUGREFMS	76	GUGRFRPB	48	GUGRHOPN	76
GUGEMW*SS	53	GUGRBOMS	48	GUGREFMS	94	GUGRFRPB	76	GUGRHOPW	48
GUGEMW*SS	81	GUGRBOMS	48	GUGREFPB	48	GUGRFRPN	48	GUGRHOPW	48
GUGEMWBBN	53	GUGRBOMS	48	GUGREFPB	76	GUGRFRPN	76	GUGRHOPW	76
GUGEMWBBN	81	GUGRBOMS	76	GUGREFPN	48	GUGRFRPW	48	GUGRHOPW	76
GUGEMWWWPN	53	GUGRBOMS	76	GUGREFPN	48	GUGRFRPW	76	GUGRHOPW	94
GUGEMWWWPN	81	GUGRBOMS	94	GUGREFPN	48	GUGRFRPW	94	GUGRHOPW	94
GUGEMWWWPW	53	GUGRBOMS	94	GUGREFPN	76	GUGRFRSS	48	GUGRHOSS	48
GUGEMWWWPW	81	GUGRBOPB	48	GUGREFPN	76	GUGRFRSS	76	GUGRHOSS	76

# Index

Reference	PG	Reference	PG	Reference	PG	Reference	PG	Reference	PG
GUGRJ11*MS	51	GUGROVBLK	94	GUGRWDPN	76	GUGS03GPW	45	GUGSATWPN	52
GUGRJ11*MS	79	GUGROVBN	48	GUGRWDPW	48	GUGS03GSS	45	GUGSATWPN	80
GUGRJ11*MS	96	GUGROVBN	76	GUGRWDPW	76	GUGS04GBN	45	GUGSATWPW	20
GUGRJ11*PB	51	GUGROVMS	48	GUGRWDPW	94	GUGS04GMS	45	GUGSATWPW	52
GUGRJ11*PB	79	GUGROVMS	76	GUGRDSS	48	GUGS04GPB	45	GUGSATWPW	80
GUGRJ11*SS	51	GUGROVMS	94	GUGRDSS	76	GUGS04GPN	45	GUGSATWPW	96
GUGRJ11*SS	79	GUGROVPB	48	GUGRDSS	94	GUGS04GPW	45	GUGSATWPW	97
GUGRJ11BBN	51	GUGROVPB	76	GUGRDYBLK	48	GUGS04GSS	45	GUGSATWPW	152
GUGRJ11BBN	79	GUGROVPN	48	GUGRDYBLK	76	GUGS06GBN	45	GUGTELM*MS	51
GUGRJ11BLK	96	GUGROVPN	76	GUGRDYBLK	94	GUGS06GMS	45	GUGTELM*MS	79
GUGRJ11WPN	51	GUGROVPW	48	GUGRDYBN	48	GUGS06GPB	45	GUGTELM*MS	96
GUGRJ11WPN	79	GUGROVPW	76	GUGRDYBN	76	GUGS06GPN	45	GUGTELM*PB	51
GUGRJ11WPW	20	GUGROVPW	94	GUGRDYMS	48	GUGS06GPW	45	GUGTELM*PB	79
GUGRJ11WPW	51	GUGROVSS	48	GUGRDYMS	76	GUGS06GSS	45	GUGTELM*SS	51
GUGRJ11WPW	79	GUGROVSS	76	GUGRDYPB	48	GUGS08GBN	45	GUGTELM*SS	79
GUGRJ11WPW	96	GUGRPB	48	GUGRDYPB	76	GUGS08GMS	45	GUGTELMBBN	51
GUGRJ11WPW	152	GUGRPB	76	GUGRDYPN	48	GUGS08GPB	45	GUGTELMBBN	79
GUGRJ45*MS	52	GUGRPN	48	GUGRDYPN	76	GUGS08GPN	45	GUGTELMBLK	96
GUGRJ45*MS	80	GUGRPN	76	GUGRDYPW	48	GUGS08GPW	45	GUGTELMWPN	51
GUGRJ45*MS	96	GUGRPW	48	GUGRDYPW	76	GUGS08GSS	45	GUGTELMWPN	79
GUGRJ45*PB	52	GUGRPW	76	GUGRDYPW	94	GUGS09GBN	46	GUGTELMWPW	20
GUGRJ45*PB	80	GUGRPW	94	GUGRDYSS	48	GUGS09GMS	46	GUGTELMWPW	51
GUGRJ45*SS	52	GUGRSS	48	GUGRDYSS	76	GUGS09GPB	46	GUGTELMWPW	79
GUGRJ45*SS	80	GUGRSS	76	GUGRWMBLK	48	GUGS09GPN	46	GUGTELMWPW	96
GUGRJ45BBN	52	GUGRSS	48	GUGRWMBLK	76	GUGS09GPW	46	GUGTELMWPW	152
GUGRJ45BBN	80	GUGRSS	76	GUGRWMBLK	94	GUGS09GSS	46	GUGTELS*MS	51
GUGRJ45BLK	96	GUGRTDBLK	48	GUGRWMBN	48	GUGS12GBN	46	GUGTELS*MS	79
GUGRJ45WPN	52	GUGRTDBLK	76	GUGRWMBN	76	GUGS12GMS	46	GUGTELS*MS	96
GUGRJ45WPN	80	GUGRTDBLK	94	GUGRWMMMS	48	GUGS12GPB	46	GUGTELS*PB	51
GUGRJ45WPW	20	GUGRTDBN	48	GUGRWMMMS	76	GUGS12GPN	46	GUGTELS*PB	79
GUGRJ45WPW	52	GUGRTDBN	48	GUGRWMMMS	94	GUGS12GPW	46	GUGTELS*SS	51
GUGRJ45WPW	80	GUGRTDBN	76	GUGRWMPB	48	GUGS12GSS	46	GUGTELS*SS	79
GUGRJ45WPW	96	GUGRTDBN	76	GUGRWMPB	76	GUGS18GBN	46	GUGTELSBBN	51
GUGRJ45WPW	152	GUGRTDMS	48	GUGRWMPN	48	GUGS18GMS	46	GUGTELSBBN	79
GUGRMS	48	GUGRTDMS	76	GUGRWMPN	76	GUGS18GPB	46	GUGTELSBLK	96
GUGRMS	76	GUGRTDMS	94	GUGRWMPW	48	GUGS18GPN	46	GUGTELSWPN	51
GUGRMS	94	GUGRTDPB	48	GUGRWMPW	76	GUGS18GPW	46	GUGTELSWPN	79
GUGRMWBLK	48	GUGRTDPB	76	GUGRWMPW	94	GUGS18GSS	46	GUGTELSWPW	20
GUGRMWBLK	76	GUGRTDPN	48	GUGRWMS	48	GUGS24GBN	46	GUGTELSWPW	51
GUGRMWBLK	94	GUGRTDPN	76	GUGRWMS	76	GUGS24GMS	46	GUGTELSWPW	79
GUGRMWBN	48	GUGRTDPW	48	GUGS01GBN	44	GUGS24GPB	46	GUGTELSWPW	96
GUGRMWBN	76	GUGRTDPW	76	GUGS01GMS	44	GUGS24GPN	46	GUGTELSWPW	152
GUGRMWMS	48	GUGRTDPW	94	GUGS01GPB	44	GUGS24GPW	46	GUMSCO	17
GUGRMWMS	76	GUGRTDSS	48	GUGS01GPN	44	GUGS24GSS	46	GUMSCO	114
GUGRMWMS	94	GUGRTDSS	76	GUGS01GPW	44	GUGSAT*MS	52	GUP1411BSS	33
GUGRMWPB	48	GUGRWDBLK	48	GUGS01GSS	44	GUGSAT*MS	80	GUP1411BSS	204
GUGRMWPB	76	GUGRWDBLK	76	GUGS02GBN	44	GUGSAT*MS	96	GUPA1411BSS	33
GUGRMWPN	48	GUGRWDBLK	94	GUGS02GMS	44	GUGSAT*MS	97	GUPA1411BSS	204
GUGRMWPN	76	GUGRWDBN	48	GUGS02GPB	44	GUGSAT*PB	52	GWP1612	177
GUGRMWPW	48	GUGRWDBN	76	GUGS02GPN	44	GUGSAT*PB	80	GWP1614	177
GUGRMWPW	76	GUGRDMS	48	GUGS02GPW	44	GUGSAT*SS	52	GWP1622	177
GUGRMWPW	94	GUGRDMS	76	GUGS02GSS	44	GUGSAT*SS	80	GWP1632	177
GUGRMWSS	48	GUGRDMS	94	GUGS03GBN	45	GUGSATBBN	52	GWP2010	177
GUGRMWSS	76	GUGRWDPB	48	GUGS03GMS	45	GUGSATBBN	80	GWP2011	177
GUGROVBLK	48	GUGRWDPB	76	GUGS03GPB	45	GUGSATBLK	96	GWP3010	176
GUGROVBLK	76	GUGRWDPN	48	GUGS03GPN	45	GUGSATBLK	97	GWP3020	176

# Index

Reference	PG	Reference	PG
GWP3050	176	SB351	82
GWP3060	176	SB351	99
GWP9000	178	SB351	118
GWPIU3020	176	SB351	132
GWPIU3020R	176	SB351	141
GWPIU3020RP	176	SB351	159
GWPIU3050	176	SB351	171
GWPIU3060	176	SB352	23
GWPIUKIT	178	SB352	54
LMCSKT1GR	144	SB352	82
LMCSKT2GR	145	SB352	99
LMCSKT2GRP	145	SB352	118
LSKT1GR	124	SB352	132
LSKT2GR	124	SB352	141
LSKT2GRP	124	SB352	159
MTN51290319	201	SB352	171
MTN550619	201	SB471	23
MTN55101119	200	SB471	55
MTN55101219	200	SB471	83
MTN55101419	200	SB471	99
MTN55101519	200	SB471	118
MTN55701019	200	SB471	132
MTN570222	201	SB471	141
SAEUEMSCDBWE	204	SB471	159
SAEUEMSCSAWE	204	SB471	171
SAEUEMSCUWE	204	SB472	23
SAEUEMSIR10T	204	SB472	55
SB161	23	SB472	83
SB161	118	SB472	99
SB161	132	SB472	118
SB161	141	SB472	132
SB161	159	SB472	141
SB161	171	SB472	159
SB161	54	SB472	171
SB161	82	TBC	107
SB161	99	TOP133A	160
SB251	23	TOP13A	160
SB251	54	TOP15AR	160
SB251	82	TOP2AR	160
SB251	99	TOP5AR	160
SB251	118	USCREW50SS	17
SB251	132	USCREW50SS	44
SB251	141	USCREW50SS	72
SB251	159	USCREW50SS	91
SB251	171	USCREW50SS	114
SB252	23	USCREW50SS	130
SB252	54	USCREW50SS	141
SB252	82	WHB320RG	183
SB252	99	WHB340RG	183
SB252	118	WHB355RG	183
SB252	132	WHC363RG	183
SB252	141		
SB252	159		
SB252	171		
SB351	23		
SB351	54		



# Notes

# Notes

# Notes



## UK contact details -

# 0870 608 8 608

Fax 0870 608 8 606

---

## Ireland contact details -

# 01 601 2200

Fax 01 601 2201

As a global specialist in energy management with operations in more than 100 countries, Schneider Electric offers integrated solutions across multiple market segments, including leadership positions in energy and infrastructure, industrial processes, building automation and data Centers/networks, as well as a broad presence in residential applications.

Focused on making energy safe, reliable, efficient, productive and green, the company's 150,000 plus employees achieved sales of 24 billion euros in 2013, through an active commitment to help individuals and organisations Make the most of their energy<sup>SM</sup>.

We are changing our brand names and becoming one Schneider Electric. You'll get the same great quality products, but from one name you can remember and trust. This provides you and your customers with the reassurance associated with Schneider Electric.

Some of our market leading brands have already become Schneider Electric including **Merlin Gerin, Telemecanique, Square D, GET, Mita, Sarel, Himel, Thorsman, Tower** and **TAC**.

Working as one Schneider Electric makes it clearer that our ranges are highly compatible for integrated solutions.

## Schneider Electric Ltd

United Kingdom  
Stafford Park 5,  
Telford  
Shropshire  
TF3 3BL  
Tel: 0870 608 8 608  
Fax: 0870 608 8 606  
[www.schneider-electric.com/uk](http://www.schneider-electric.com/uk)

Ireland  
Head office,  
Block a  
Maynooth Business Campus  
Maynooth, Co. Kildare  
Tel: (01) 601 2200  
Fax: (01) 601 2201  
[www.schneider-electric.com/ie](http://www.schneider-electric.com/ie)

Schneider Electric Limited is a company registered in England and Wales.  
Registered number: 1407228. Registered office: Stafford Park 5, Telford, Shropshire TF3 3BL.

© 2015 Schneider Electric. All Rights Reserved. Schneider Electric, Active Energy Management, Compact, EcoStruxure, ION Enterprise, iRIO, Make the most of your energy, Masterpact, Micrologic, Power Plant To Plug, Modbus and PowerLogic are owned by Schneider Electric Industries SAS, or its affiliated companies in the United States and other countries.

As standards, specifications and designs change from time to time, please ask for confirmation of the information given in this publication.

member of

